

LabVIEW™

Getting Started with LabVIEW

Worldwide Technical Support and Product Information

ni.com

National Instruments Corporate Headquarters

11500 North Mopac Expressway Austin, Texas 78759-3504 USA Tel: 512 683 0100

Worldwide Offices

Australia 1800 300 800, Austria 43 662 457990-0, Belgium 32 (0) 2 757 0020, Brazil 55 11 3262 3599,
Canada 800 433 3488, China 86 21 5050 9800, Czech Republic 420 224 235 774, Denmark 45 45 76 26 00,
Finland 358 (0) 9 725 72511, France 01 57 66 24 24, Germany 49 89 7413130, India 91 80 41190000,
Israel 972 3 6393737, Italy 39 02 41309277, Japan 0120-527196, Korea 82 02 3451 3400,
Lebanon 961 (0) 1 33 28 28, Malaysia 1800 887710, Mexico 01 800 010 0793, Netherlands 31 (0) 348 433 466,
New Zealand 0800 553 322, Norway 47 (0) 66 90 76 60, Poland 48 22 328 90 10, Portugal 351 210 311 210,
Russia 7 495 783 6851, Singapore 1800 226 5886, Slovenia 386 3 425 42 00, South Africa 27 0 11 805 8197,
Spain 34 91 640 0085, Sweden 46 (0) 8 587 895 00, Switzerland 41 56 2005151, Taiwan 886 02 2377 2222,
Thailand 662 278 6777, Turkey 90 212 279 3031, United Kingdom 44 (0) 1635 523545

For further support information, refer to the *Technical Support and Professional Services* appendix. To comment on National Instruments documentation, refer to the National Instruments Web site at ni.com/info and enter the Info Code `feedback`.

Important Information

Warranty

The media on which you receive National Instruments software are warranted not to fail to execute programming instructions, due to defects in materials and workmanship, for a period of 90 days from date of shipment, as evidenced by receipts or other documentation. National Instruments will, at its option, repair or replace software media that do not execute programming instructions if National Instruments receives notice of such defects during the warranty period. National Instruments does not warrant that the operation of the software shall be uninterrupted or error free.

A Return Material Authorization (RMA) number must be obtained from the factory and clearly marked on the outside of the package before any equipment will be accepted for warranty work. National Instruments will pay the shipping costs of returning to the owner parts which are covered by warranty.

National Instruments believes that the information in this document is accurate. The document has been carefully reviewed for technical accuracy. In the event that technical or typographical errors exist, National Instruments reserves the right to make changes to subsequent editions of this document without prior notice to holders of this edition. The reader should consult National Instruments if errors are suspected. In no event shall National Instruments be liable for any damages arising out of or related to this document or the information contained in it.

EXCEPT AS SPECIFIED HEREIN, NATIONAL INSTRUMENTS MAKES NO WARRANTIES, EXPRESS OR IMPLIED, AND SPECIFICALLY DISCLAIMS ANY WARRANTY OF MERCHANTABILITY OR FITNESS FOR A PARTICULAR PURPOSE. CUSTOMER'S RIGHT TO RECOVER DAMAGES CAUSED BY FAULT OR NEGLIGENCE ON THE PART OF NATIONAL INSTRUMENTS SHALL BE LIMITED TO THE AMOUNT THEREFORE PAID BY THE CUSTOMER. NATIONAL INSTRUMENTS WILL NOT BE LIABLE FOR DAMAGES RESULTING FROM LOSS OF DATA, PROFITS, USE OF PRODUCTS, OR INCIDENTAL OR CONSEQUENTIAL DAMAGES, EVEN IF ADVISED OF THE POSSIBILITY THEREOF. This limitation of the liability of National Instruments will apply regardless of the form of action, whether in contract or tort, including negligence. Any action against National Instruments must be brought within one year after the cause of action accrues. National Instruments shall not be liable for any delay in performance due to causes beyond its reasonable control. The warranty provided herein does not cover damages, defects, malfunctions, or service failures caused by owner's failure to follow the National Instruments installation, operation, or maintenance instructions; owner's modification of the product; owner's abuse, misuse, or negligent acts; and power failure or surges, fire, flood, accident, actions of third parties, or other events outside reasonable control.

Copyright

Under the copyright laws, this publication may not be reproduced or transmitted in any form, electronic or mechanical, including photocopying, recording, storing in an information retrieval system, or translating, in whole or in part, without the prior written consent of National Instruments Corporation.

National Instruments respects the intellectual property of others, and we ask our users to do the same. NI software is protected by copyright and other intellectual property laws. Where NI software may be used to reproduce software or other materials belonging to others, you may use NI software only to reproduce materials that you may reproduce in accordance with the terms of any applicable license or other legal restriction.

For copyright notices, conditions, and disclaimers, including information regarding certain third-party components used in LabVIEW, refer to the *Copyright* topic of the *LabVIEW Help*.

Trademarks

CVI, LabVIEW, National Instruments, NI, ni.com, the National Instruments corporate logo, and the Eagle logo are trademarks of National Instruments Corporation. Refer to the *Trademark Information* at ni.com/trademarks for other National Instruments trademarks.

The mark LabWindows is used under a license from Microsoft Corporation. Windows is a registered trademark of Microsoft Corporation in the United States and other countries. Other product and company names mentioned herein are trademarks or trade names of their respective companies.

Members of the National Instruments Alliance Partner Program are business entities independent from National Instruments and have no agency, partnership, or joint-venture relationship with National Instruments.

Patents

For patents covering National Instruments products/technology, refer to the appropriate location: **Help»Patents** in your software, the `patents.txt` file on your media, or the *National Instruments Patent Notice* at ni.com/patents.

WARNING REGARDING USE OF NATIONAL INSTRUMENTS PRODUCTS

(1) NATIONAL INSTRUMENTS PRODUCTS ARE NOT DESIGNED WITH COMPONENTS AND TESTING FOR A LEVEL OF RELIABILITY SUITABLE FOR USE IN OR IN CONNECTION WITH SURGICAL IMPLANTS OR AS CRITICAL COMPONENTS IN ANY LIFE SUPPORT SYSTEMS WHOSE FAILURE TO PERFORM CAN REASONABLY BE EXPECTED TO CAUSE SIGNIFICANT INJURY TO A HUMAN.

(2) IN ANY APPLICATION, INCLUDING THE ABOVE, RELIABILITY OF OPERATION OF THE SOFTWARE PRODUCTS CAN BE IMPAIRED BY ADVERSE FACTORS, INCLUDING BUT NOT LIMITED TO FLUCTUATIONS IN ELECTRICAL POWER SUPPLY, COMPUTER HARDWARE MALFUNCTIONS, COMPUTER OPERATING SYSTEM SOFTWARE FITNESS, FITNESS OF COMPILERS AND DEVELOPMENT SOFTWARE USED TO DEVELOP AN APPLICATION, INSTALLATION ERRORS, SOFTWARE AND HARDWARE COMPATIBILITY PROBLEMS, MALFUNCTIONS OR FAILURES OF ELECTRONIC MONITORING OR CONTROL DEVICES, TRANSIENT FAILURES OF ELECTRONIC SYSTEMS (HARDWARE AND/OR SOFTWARE), UNANTICIPATED USES OR MISUSES, OR ERRORS ON THE PART OF THE USER OR APPLICATIONS DESIGNER (ADVERSE FACTORS SUCH AS THESE ARE HEREAFTER COLLECTIVELY TERMED "SYSTEM FAILURES"). ANY APPLICATION WHERE A SYSTEM FAILURE WOULD CREATE A RISK OF HARM TO PROPERTY OR PERSONS (INCLUDING THE RISK OF BODILY INJURY AND DEATH) SHOULD NOT BE RELIANT SOLELY UPON ONE FORM OF ELECTRONIC SYSTEM DUE TO THE RISK OF SYSTEM FAILURE. TO AVOID DAMAGE, INJURY, OR DEATH, THE USER OR APPLICATION DESIGNER MUST TAKE REASONABLY PRUDENT STEPS TO PROTECT AGAINST SYSTEM FAILURES, INCLUDING BUT NOT LIMITED TO BACK-UP OR SHUT DOWN MECHANISMS. BECAUSE EACH END-USER SYSTEM IS CUSTOMIZED AND DIFFERS FROM NATIONAL INSTRUMENTS' TESTING PLATFORMS AND BECAUSE A USER OR APPLICATION DESIGNER MAY USE NATIONAL INSTRUMENTS PRODUCTS IN

COMBINATION WITH OTHER PRODUCTS IN A MANNER NOT EVALUATED OR CONTEMPLATED BY NATIONAL INSTRUMENTS. THE USER OR APPLICATION DESIGNER IS ULTIMATELY RESPONSIBLE FOR VERIFYING AND VALIDATING THE SUITABILITY OF NATIONAL INSTRUMENTS PRODUCTS WHENEVER NATIONAL INSTRUMENTS PRODUCTS ARE INCORPORATED IN A SYSTEM OR APPLICATION, INCLUDING, WITHOUT LIMITATION, THE APPROPRIATE DESIGN, PROCESS AND SAFETY LEVEL OF SUCH SYSTEM OR APPLICATION.

Contents

About This Manual

Conventions	ix
Related Documentation.....	x

Chapter 1

Getting Started with LabVIEW Virtual Instruments

Building a Virtual Instrument	1-2
Launching LabVIEW	1-3
Opening a New VI from a Template	1-4
Adding a Control to the Front Panel.....	1-6
Changing a Signal Type	1-8
Wiring Objects on the Block Diagram	1-10
Running a VI	1-11
Modifying a Signal	1-11
Displaying Two Signals on a Graph.....	1-15
Customizing a Knob Control.....	1-16
Customizing a Waveform Graph.....	1-17
Summary.....	1-18
New Dialog Box and Template VIs	1-18
Front Panel.....	1-19
Block Diagram.....	1-19
Front Panel and Block Diagram Tools	1-19
Running and Stopping a VI	1-20
Express VIs.....	1-20
LabVIEW Documentation Resources	1-20
Property Dialog Boxes	1-21
Shortcuts	1-21

Chapter 2

Customizing a VI

Building a VI from a Blank VI	2-1
Opening a Blank VI.....	2-2
Adding an Express VI That Simulates a Signal	2-2
Searching the Help and Modifying a Signal.....	2-3
Customizing a User Interface from the Block Diagram	2-5
Configuring a VI to Run Continuously until the User Stops It	2-6
Using the Error List Window	2-8
Controlling the Speed of Execution	2-9

Using a Table to Display Data	2-9
Searching for Examples	2-11
Summary.....	2-12
Using the LabVIEW Help Resources	2-12
Customizing the Block Diagram Code	2-13
Creating Controls and Indicators	2-13
Controlling When a VI Stops Running.....	2-14
Errors and Broken Wires	2-14
Displaying Data in a Table	2-14
Using the NI Example Finder	2-14
Shortcuts.....	2-15

Chapter 3

Analyzing and Saving a Signal

Building an Analysis VI.....	3-2
Modifying a VI Created from a Template	3-2
Adding a Signal.....	3-4
Adding Two Signals.....	3-5
Filtering a Signal.....	3-7
Modifying the Appearance of Graphs.....	3-8
Analyzing the Amplitude of a Signal.....	3-9
Controlling the Speed of Execution	3-9
Adding a Warning Light	3-10
Setting a Warning Level Limit.....	3-11
Warning the User	3-12
Configuring a VI to Save Data to a File.....	3-13
Saving Data to a File.....	3-14
Adding a Button That Stores Data When Clicked	3-14
Saving Data When Prompted by a User.....	3-15
Viewing Saved Data.....	3-16
Summary.....	3-17
Controls and Indicators	3-17
Filtering Data	3-17
Saving Data	3-17

Chapter 4

Hardware: Acquiring Data and Communicating with Instruments (Windows)

Hardware and Software Requirements	4-1
Acquiring a Signal in NI-DAQmx	4-2
Creating an NI-DAQmx Task	4-2
Graphing Data from a DAQ Device	4-5

Editing an NI-DAQmx Task	4-6
Visually Comparing Two Voltage Readings.....	4-7
Communicating with an Instrument: Using Instrument Drivers and the	
Instrument I/O Assistant	4-7
Getting Started with the Instrument Driver Finder.....	4-8
Finding and Installing Instrument Drivers	4-8
Using Instrument Drivers	4-9
Selecting an Instrument Using the Instrument I/O Assistant	4-10
Acquiring and Parsing Information for an Instrument	4-11
Wiring a Command to an Instrument	4-12
Summary	4-12
DAQ Assistant Express VI.....	4-12
Tasks in NI-DAQmx	4-13
Instrument Drivers.....	4-13
Instrument I/O Assistant Express VI.....	4-14

Chapter 5

Using Other LabVIEW Features

All Controls and Indicators	5-1
All VIs and Functions	5-2
VIs	5-2
Functions	5-3
Data Types	5-3
When to Use Other LabVIEW Features	5-4

Appendix A

Technical Support and Professional Services

Glossary

Index

About This Manual

Use this manual as a tutorial to familiarize yourself with the LabVIEW graphical programming environment and the basic LabVIEW features you use to build data acquisition and instrument control applications.

This manual contains exercises that you can use to learn how to develop basic applications in LabVIEW. These exercises take a short amount of time to complete and help you get started with LabVIEW.

The end of each chapter includes a summary of the main concepts taught in that chapter. Use these summaries to review what you learned.

Conventions

The following conventions appear in this manual:

»

The » symbol leads you through nested menu items and dialog box options to a final action. The sequence **File»Page Setup»Options** directs you to pull down the **File** menu, select the **Page Setup** item, and select **Options** from the last dialog box.



This icon denotes a tip, which alerts you to advisory information.



This icon denotes a note, which alerts you to important information.

bold

Bold text denotes items that you must select or click in the software, such as menu items and dialog box options. Bold text also denotes parameter names, controls and indicators on the front panel, dialog boxes, sections of dialog boxes, menu names, and palette names.

italic

Italic text denotes variables, emphasis, a cross-reference, or an introduction to a key concept. Italic text also denotes text that is a placeholder for a word or value that you must supply.

monospace

Text in this font denotes text or characters that you should enter from the keyboard, sections of code, programming examples, and syntax examples. This font is also used for the proper names of disk drives, paths, directories, programs, subprograms, subroutines, device names, operations, variables, filenames, and extensions.

monospace bold	Bold text in this font denotes the messages and responses that the computer automatically prints to the screen. This font also emphasizes lines of code that are different from the other examples.
Platform	Text in this font denotes a specific platform and indicates that the text following it applies only to that platform.
right-click	(Mac OS X) Press <Command>-click to perform the same action as a right-click.

Related Documentation

The following documents contain information that you may find helpful as you read this manual:

- *LabVIEW Release Notes*—Use these release notes to install and uninstall LabVIEW. The release notes also describe the system requirements for the LabVIEW software, including the LabVIEW Application Builder.
- *LabVIEW Help*—Use the *LabVIEW Help* to access information about LabVIEW programming concepts, step-by-step instructions for using LabVIEW, and reference information about LabVIEW VIs, functions, palettes, menus, tools, properties, methods, events, dialog boxes, and so on. The *LabVIEW Help* also lists the LabVIEW documentation resources available from National Instruments. Access the *LabVIEW Help* by selecting **Help»LabVIEW Help**.
- *LabVIEW Quick Reference Card*—Use this card as a reference for information about help resources, keyboard shortcuts, data type terminals, and tools for editing, execution, and debugging.

Getting Started with LabVIEW Virtual Instruments

LabVIEW programs are called virtual instruments, or VIs, because their appearance and operation imitate physical instruments, such as oscilloscopes and multimeters. LabVIEW contains a comprehensive set of tools for acquiring, analyzing, displaying, and storing data, as well as tools to help you troubleshoot code you write.

In LabVIEW, you build a user interface, or front panel, with controls and indicators. Controls are knobs, push buttons, dials, and other input mechanisms. Indicators are graphs, LEDs, and other output displays. After you build the front panel, you add code using VIs and structures to control the front panel objects. The block diagram contains this code.

You can use LabVIEW to communicate with hardware such as data acquisition, vision, and motion control devices, as well as GPIB, PXI, VXI, RS232, and RS485 instruments.

Building a Virtual Instrument

In the following exercises, you will build a VI that generates a signal and displays that signal in a graph. After you complete the exercises, the front panel of the VI will look similar to the front panel in Figure 1-1.



You can complete the exercises in this chapter in approximately 40 minutes.

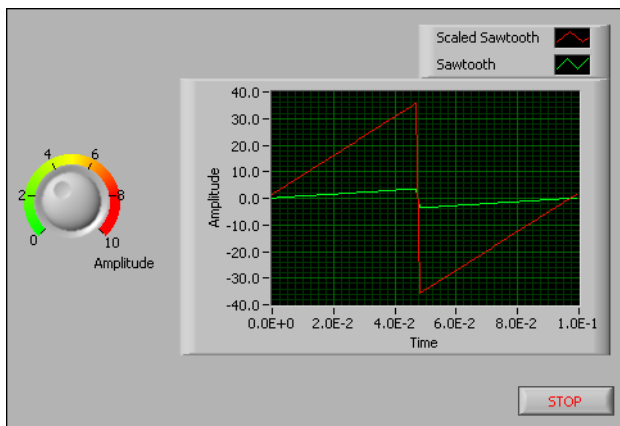

Figure 1-1. Front Panel of the Acquiring a Signal VI

Launching LabVIEW

The **Getting Started** window, shown in Figure 1-2, appears when you launch LabVIEW. Use this window to create new VIs, select among the most recently opened LabVIEW files, find examples, and launch the *LabVIEW Help*. You also can access information and resources to help you learn about LabVIEW, such as specific manuals, help topics, and resources on the National Instruments Web site, ni.com.

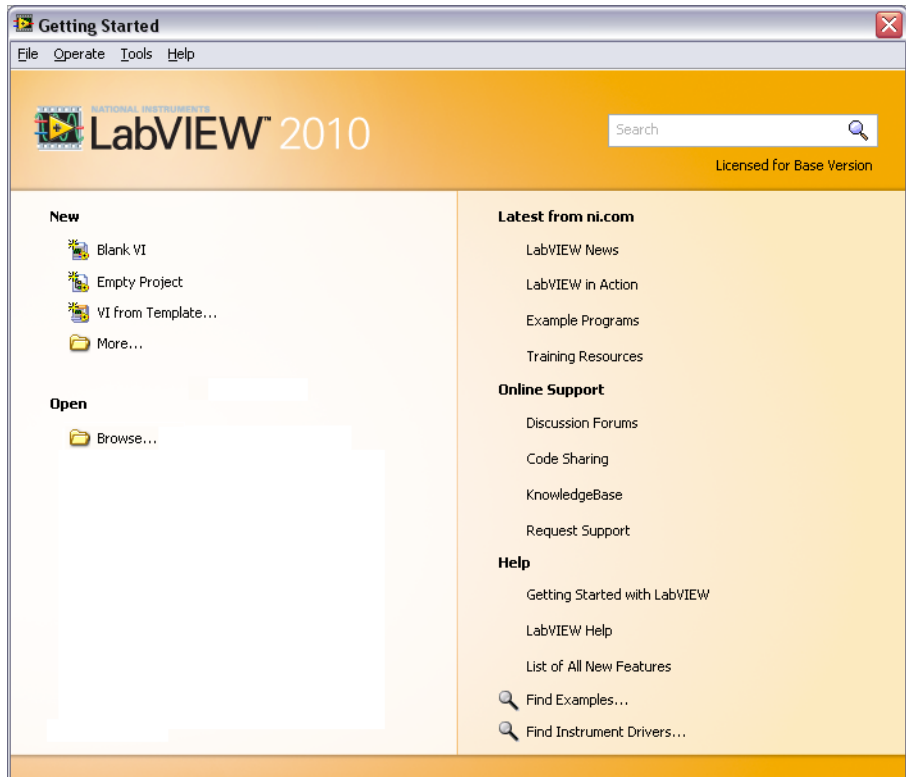

Figure 1-2. Getting Started Window

The **Getting Started** window disappears when you open an existing file or create a new file. The **Getting Started** window reappears when you close all open front panels and block diagrams. You also can display the window from the front panel or block diagram by selecting **View»Getting Started Window**.

Opening a New VI from a Template

LabVIEW provides built-in template VIs that include the subVIs, functions, structures, and front panel objects you need to get started building common measurement applications.

Complete the following steps to create a VI that generates a signal and displays it in the front panel window.

1. Launch LabVIEW.
2. In the **Getting Started** window, click the **New** or **VI from Template** link to display the **New** dialog box.
3. From the **Create New** list, select **VI»From Template»Tutorial (Getting Started)»Generate and Display**. This template VI generates and displays a signal.

A preview and a brief description of the template VI appear in the **Description** section. Figure 1-3 shows the **New** dialog box and the preview of the Generate and Display template VI.

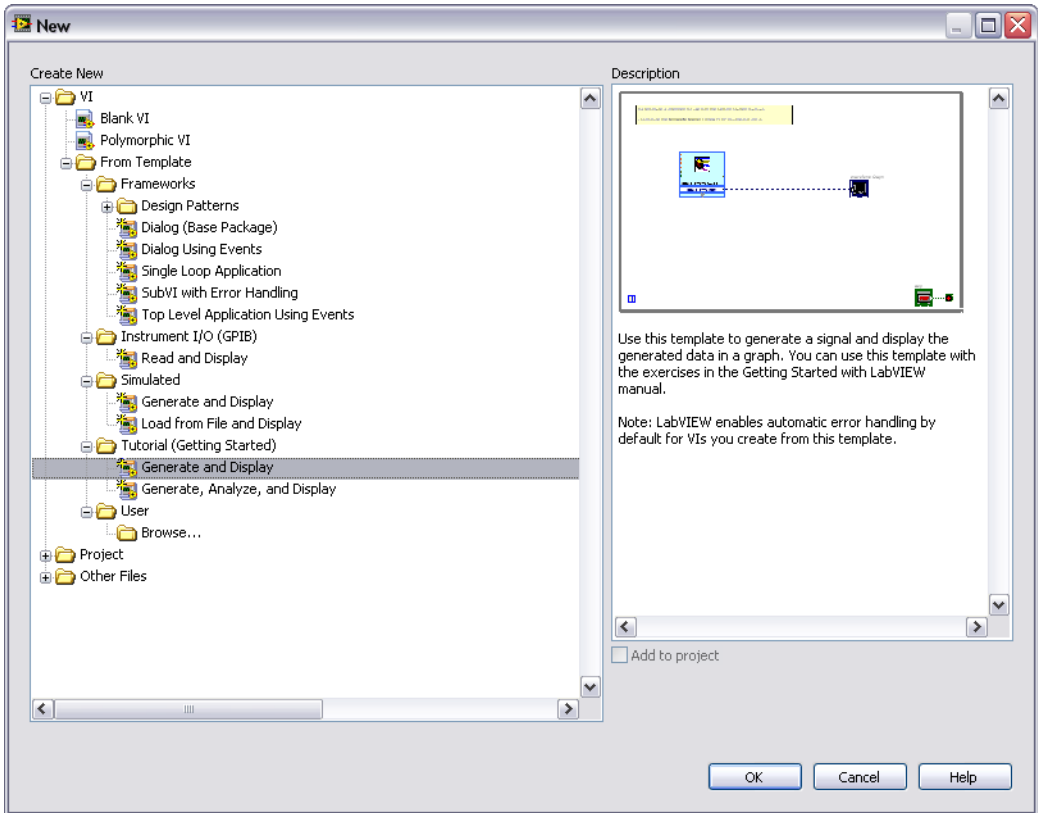

Figure 1-3. New Dialog Box

4. Click the **OK** button to create a VI from the template. You also can double-click the name of the template VI in the **Create New** list to create a VI from a template.

LabVIEW displays two windows: the front panel window and the block diagram window.

5. Examine the front panel window.

The user interface, or front panel, appears with a gray background and includes controls and indicators. The title bar of the front panel indicates that this window is the front panel for the Generate and Display VI.



Note If the front panel is not visible, you can display the front panel by selecting **Window»Show Front Panel**. You also can switch between the front panel window and block diagram window at any time by pressing the <Ctrl-E> keys. The <Ctrl> key in keyboard shortcuts corresponds to the (**Mac OS X**) <Option> or <Command> key or (**Linux**) <Alt> key.

6. Select **Window»Show Block Diagram** and examine the block diagram of the VI.

The block diagram appears with a white background and includes VIs and structures that control the front panel objects. The title bar of the block diagram indicates that this window is the block diagram for the Generate and Display VI.



7. On the front panel toolbar, click the **Run** button, shown at left. You also can press the <Ctrl-R> keys to run a VI.

A sine wave appears on the graph in the front panel window.



8. Stop the VI by clicking the front panel **STOP** button, shown at left.

Adding a Control to the Front Panel

Front panel controls simulate the input mechanisms on a physical instrument and supply data to the block diagram of the VI. Many physical instruments have knobs you can turn to change an input value.

Complete the following steps to add a knob control to the front panel.



Tip Throughout these exercises, you can undo recent edits by selecting **Edit»Undo** or pressing the <Ctrl-Z> keys.

1. If the **Controls** palette, shown in Figure 1-4, is not visible in the front panel window, select **View»Controls Palette**.



Tip You can right-click any blank space in the front panel or the block diagram to display a temporary version of the **Controls** or **Functions** palette. The **Controls** or **Functions** palette appears with a thumbtack icon in the upper left corner. Click the thumbtack to pin the palette so it is no longer temporary.

- If you are a new LabVIEW user, the **Controls** palette opens with the **Express** palette, shown in Figure 1-4, visible by default. If you do not see the **Express** palette, click **Express** on the **Controls** palette to display the **Express** palette.

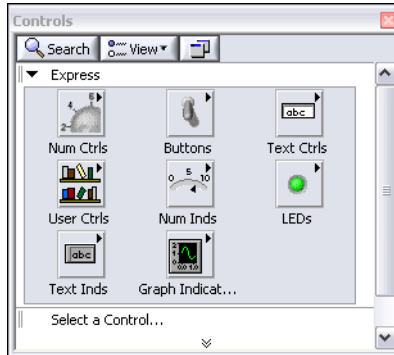

Figure 1-4. Controls Palette

- Move the cursor over the icons on the **Express** palette to locate the **Numeric Controls** palette.

When you move the cursor over icons on the **Controls** palette, the name of the subpalette, control, or indicator appears in a tip strip below the icon.



Note Some palette objects display a short name on the palette that is different from the name that appears in the tip strip. The short name abbreviates the name of the palette object so that it fits in the space available on the palette. If you have difficulty finding a palette object by its short name, use the **Search** button on the **Controls** or **Functions** palette to find the palette object by name.

- Click the **Numeric Controls** icon to display the **Numeric Controls** palette.
- Click the **Knob** control on the **Numeric Controls** palette to attach the control to the cursor, and then add the knob to the front panel to the left of the waveform graph.

You will use this knob in a later exercise to control the amplitude of a signal.

- Select **File»Save As** and save the VI as `Acquiring a Signal.vi` in an easily accessible location.

Changing a Signal Type

The block diagram has a blue icon labeled **Simulate Signal**. This icon represents the Simulate Signal Express VI. An Express VI is a component of the block diagram that you can configure to perform common measurement tasks. The Simulate Signal Express VI simulates a sine wave by default.

Complete the following steps to change this signal to a sawtooth wave.

1. Display the block diagram by pressing the <Ctrl-E> keys or by clicking the block diagram.



2. Right-click the Simulate Signal Express VI and select **Properties** from the shortcut menu to display the **Configure Simulate Signal** dialog box. **(Mac OS X)** Press <Command>-click to perform the same action as right-click.



Tip You also can double-click the Express VI to display the **Configure Simulate Signal** dialog box.

3. Select **Sawtooth** from the **Signal type** pull-down menu.

The waveform on the graph in the **Result Preview** section changes to a sawtooth wave. The **Configure Simulate Signal** dialog box should appear similar to Figure 1-5.

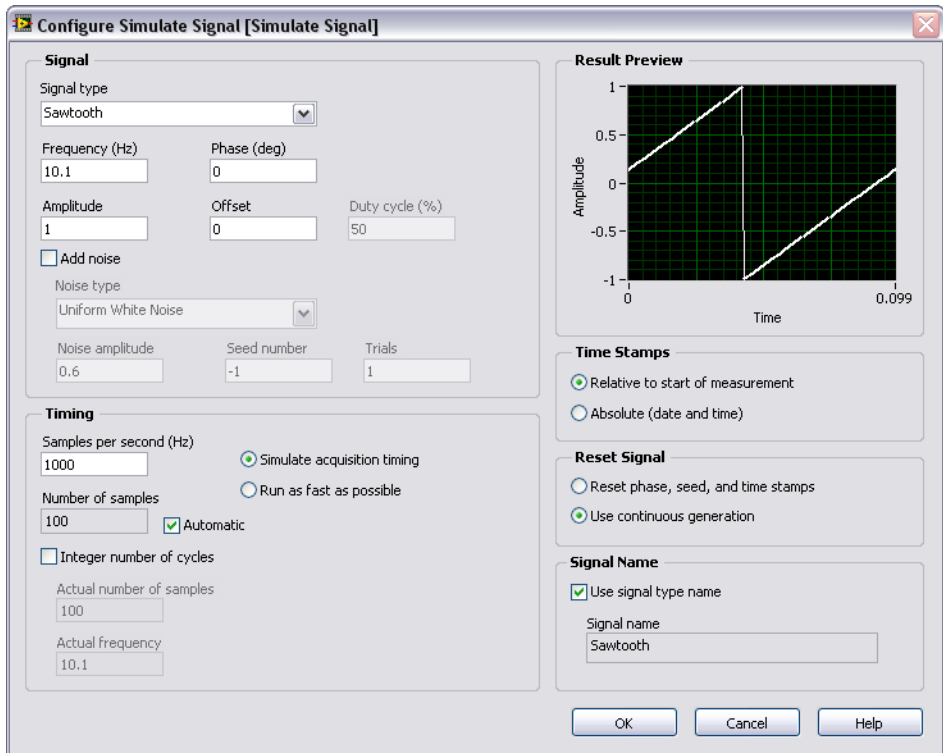

Figure 1-5. Configure Simulate Signal Dialog Box

4. Click the **OK** button to save the current configuration and close the **Configure Simulate Signal** dialog box.
5. Move the cursor over the down arrows at the bottom of the Simulate Signal Express VI. The down arrows indicate you can reveal hidden inputs and outputs by extending the border of the Express VI.
6. When a double-headed arrow appears, shown at left, click and drag the border of the Express VI to add two rows. When you release the border, the **Amplitude** input appears.



In Figure 1-5, notice that **Amplitude** is an option in the **Configure Simulate Signal** dialog box. When inputs, such as **Amplitude**, appear on the block diagram and in the configuration dialog box, you can configure the inputs in either location.

Wiring Objects on the Block Diagram

To use the knob to change the amplitude of the signal, you must connect two objects on the block diagram.

Complete the following steps to wire the knob to the **Amplitude** input of the Simulate Signal Express VI.



1. On the block diagram, move the cursor over the **Knob** terminal, shown at left.

The cursor becomes an arrow, or the Positioning tool, shown at left. Use the Positioning tool to select, position, and resize objects.



Note You can resize only loops and structures on the block diagram. Go to the front panel to resize objects you have added to the front panel.



2. Use the Positioning tool to select the **Knob** terminal and make sure it is to the left of the Simulate Signal Express VI and inside the gray loop, shown at left.

The terminals inside the loop are representations of front panel controls and indicators. Terminals are entry and exit ports that exchange information between the front panel and block diagram.

3. Deselect the **Knob** terminal by clicking a blank space on the block diagram. If you want to use a different tool with an object, you must deselect the object to switch the tool.



4. Move the cursor over the arrow on the **Knob** terminal, shown at left.

The cursor becomes a wire spool, or the Wiring tool, shown at left. Use the Wiring tool to wire objects together on the block diagram.

5. When the Wiring tool appears, click the arrow on the **Knob** terminal and then click the arrow on the **Amplitude** input of the Simulate Signal Express VI, shown at left, to wire the two objects together.

A wire appears and connects the two objects. Data flows along this wire from the Knob terminal to the Express VI.

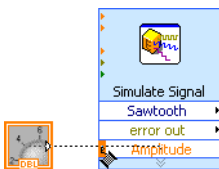

6. Select **File»Save** to save the VI.

Running a VI

Running a VI executes the solution.

Complete the following steps to run the Acquiring a Signal VI.

1. Display the front panel by pressing the <Ctrl-E> keys or by clicking the front panel.
2. Click the **Run** button or press the <Ctrl-R> keys to run the VI.
3. Move the cursor over the knob.



The cursor becomes a hand, or the Operating tool, shown at left. Use the Operating tool to change the value of a control.

4. Using the Operating tool, turn the knob to adjust the amplitude of the sawtooth wave.

The amplitude of the sawtooth wave changes as you turn the knob. As you change the amplitude, the Operating tool displays a tip strip that indicates the numeric value of the knob. The y-axis on the graph scales automatically to account for the change in amplitude.



To indicate that the VI is running, the **Run** button changes to a darkened arrow, shown at left. You can change the value of most controls while a VI runs, but you cannot edit the VI in other ways while the VI runs.



5. Click the **STOP** button, shown at left, to stop the VI.

The **STOP** button stops the VI after the loop completes its current iteration. The **Abort Execution** button, shown at left, stops the VI immediately, before the VI finishes the current iteration. Aborting a VI that uses external resources, such as external hardware, might leave the resources in an unknown state by not resetting or releasing them properly. Design the VIs you create with a stop button to avoid this problem.



Modifying a Signal

Complete the following steps to scale the signal by 10 and display the results in the front panel graph.

1. In the block diagram, use the Positioning tool to click the wire that connects the Simulate Signal Express VI to the **Waveform Graph** terminal, shown at left.
2. Press the <Delete> key to delete this wire.

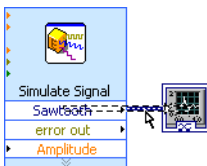

3. If the **Functions** palette, shown in Figure 1-6, is not visible, select **View»Functions Palette** to display it. The **Functions** palette opens with the **Express** palette visible by default. If you have selected another palette, you can return to the **Express** palette by clicking **Express** on the **Functions** palette.

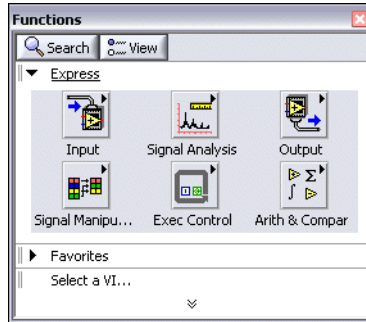
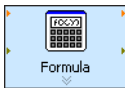

Figure 1-6. Functions Palette



4. On the **Arithmetic & Comparison** palette, select the **Formula Express VI**, shown at left, and place it on the block diagram between the **Simulate Signal Express VI** and the **Waveform Graph** terminal. You can move the **Waveform Graph** terminal to the right to make more room between the **Express VI** and the terminal.

The **Configure Formula** dialog box appears when you place the **Express VI** on the block diagram. When you place an **Express VI** on the block diagram, the configuration dialog box for that **VI** always appears automatically.



Note If you place an object too close to another object on the block diagram, auto wiring might wire the two objects together. Delete the wires if the automatic wiring is wrong. To configure auto wiring select **Tools»Options** then select **Block Diagram** from the **Category** list. Remove the checkmark from the **Enable auto wiring** checkbox to turn off auto wiring.



5. Click the **Help** button, shown at left, in the bottom right corner of the **Configure Formula** dialog box to display the *LabVIEW Help* topic for this **Express VI**.

The *Formula* help topic describes the **Express VI**, the configuration dialog box options, and the inputs and outputs of the **Express VI**. Each **Express VI** has a corresponding help topic you can access by clicking the **Help** button in the configuration dialog box or by right-clicking the **Express VI** and selecting **Help** from the shortcut menu.

6. In the *Formula* topic, find the dialog box option whose description indicates that it enters a variable into the formula.
7. Minimize the *LabVIEW Help* to return to the **Configure Formula** dialog box.
8. Change the text in the **Label** column of the dialog box option you read about, shown at left, from **x1** to **Sawtooth** to indicate the input value to the Formula Express VI. When you click in the **Formula** text box at the top of the **Configure Formula** dialog box, the text changes to match the label you entered.
9. Define the value of the scaling factor by entering ***10** after **Sawtooth** in the **Formula** text box.

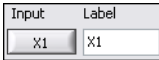

You can use the **Input** buttons in the configuration dialog box or you can use the *, 1, and 0 keyboard buttons to enter the scaling factor. If you use the **Input** buttons in the configuration dialog box, LabVIEW places the formula input after the **Sawtooth** input in the **Formula** text box. If you use the keyboard, click in the **Formula** text box after **Sawtooth** and enter the formula you want to appear in the text box. The **Configure Formula** dialog box should appear similar to Figure 1-7.

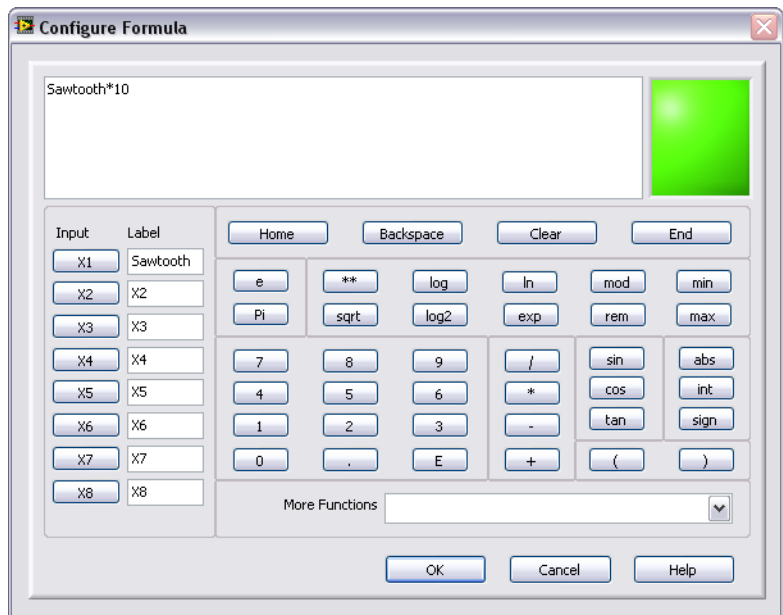

Figure 1-7. Configure Formula Dialog Box



Note If you enter an invalid formula in the **Formula** text box, the **Errors** LED in the upper right corner turns from green to gray and displays the text **Invalid Formula**.

10. Click the **OK** button to save the current configuration and close the **Configure Formula** dialog box.

11. Move the cursor over the arrow on the **Sawtooth** output of the Simulate Signal Express VI.

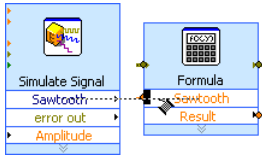

12. When the Wiring tool appears, click the arrow on the **Sawtooth** output and then click the arrow on the **Sawtooth** input of the Formula Express VI, shown at left, to wire the two objects together.

13. Use the Wiring tool to wire the **Result** output of the Formula Express VI to the **Waveform Graph** terminal.

Examine the wires connecting the Express VIs and terminals. The arrows on the Express VIs and terminals indicate the direction that the data flows along these wires. The block diagram should appear similar to Figure 1-8. Use the block diagram figures as a reference. The arrangement of objects on your block diagram does not need to match the figure exactly.

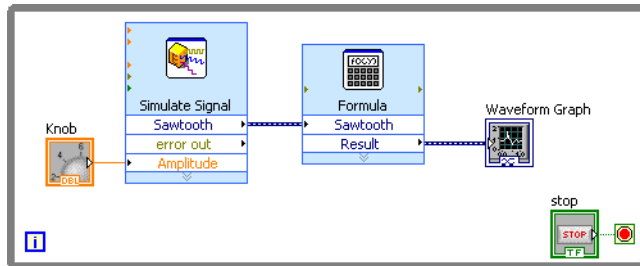

Figure 1-8. Block Diagram of the Acquiring a Signal VI



Tip You can right-click any wire and select **Clean Up Wire** from the shortcut menu to have LabVIEW automatically find a route for the wire around existing objects on the block diagram. LabVIEW also routes a wire to decrease the number of bends in the wire. You also can click the **Clean Up Diagram** button on the block diagram toolbar to have LabVIEW automatically reroute all existing wires and rearrange objects on the block diagram to generate a cleaner look.

14. Press the <Ctrl-S> keys or select **File»Save** to save the VI.

Displaying Two Signals on a Graph

To compare the signal generated by the Simulate Signal Express VI and the signal modified by the Formula Express VI on the same graph, use the Merge Signals function.

Complete the following steps to display two signals on the same graph.

1. In the block diagram, move the cursor over the arrow on the **Sawtooth** output of the Simulate Signal Express VI.
2. Use the Wiring tool to wire the **Sawtooth** output to the **Waveform Graph** terminal.



The Merge Signals function, shown at left, appears where the two wires connect. A function is a built-in execution element, comparable to an operator, function, or statement in a text-based programming language. The Merge Signals function takes the two separate signals and combines them so that both can display on the same graph.

The block diagram should appear similar to Figure 1-9.

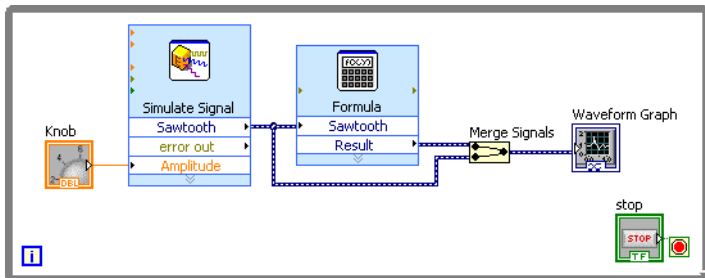

Figure 1-9. Block Diagram Showing the Merge Signals Function

3. Press the <Ctrl-S> keys or select **File»Save** to save the VI.
4. Return to the front panel, run the VI, and turn the knob control.

The graph plots the original sawtooth wave and the scaled sawtooth wave with 10 times the amplitude, as you specified in the Formula Express VI. The maximum value on the y-axis automatically scales as you turn the knob.

5. Click the **STOP** button to stop the VI.

Customizing a Knob Control

The knob control changes the amplitude of the sawtooth wave, so labeling it **Amplitude** accurately describes the behavior of the knob.

Complete the following steps to customize the appearance of the knob.

1. Right-click the front panel knob and select **Properties** from the shortcut menu to display the **Knob Properties** dialog box. Click the **Appearance** tab to display the **Appearance** page.
2. In the **Label** section on the **Appearance** page, delete the label **Knob**, and enter `Amplitude` in the text box.

The **Knob Properties** dialog box should appear similar to Figure 1-10.

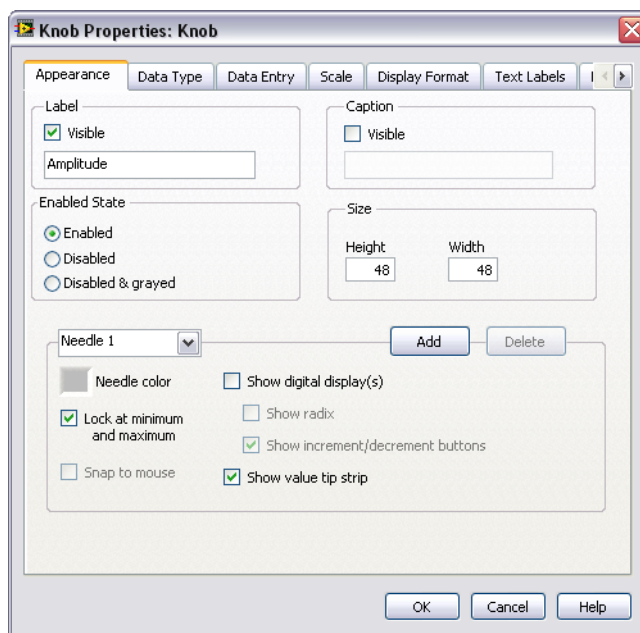

Figure 1-10. Knob Properties Dialog Box

3. Click the **Scale** tab. In the **Scale Style** section, place a checkmark in the **Show color ramp** checkbox.

The knob in the front panel window updates to reflect these changes.

4. Click the **OK** button to save the current configuration and close the **Knob Properties** dialog box.
5. Save the VI.

6. Reopen the **Knob Properties** dialog box and experiment with other properties of the knob. For example, on the **Scale** page, try changing the colors for the **Marker text color** by clicking the color box.
7. Click the **Cancel** button to avoid applying any changes you made while experimenting. If you want to keep the changes you made, click the **OK** button.

Customizing a Waveform Graph

The waveform graph indicator displays the two signals. To indicate which plot is the scaled signal and which is the simulated signal, you can customize the plots.

Complete the following steps to customize the appearance of the waveform graph indicator.

1. In the front panel window, move the cursor over the top of the plot legend on the waveform graph.

Though the graph has two plots, the plot legend displays only one plot.

2. When a double-headed arrow appears, shown in Figure 1-11, click and drag the border of the plot legend to add one item to the legend. When you release the mouse button, the second plot name appears.

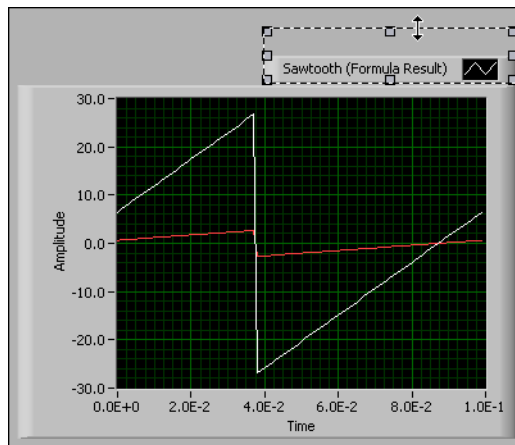

Figure 1-11. Expanding a Plot Legend

3. Right-click the waveform graph and select **Properties** from the shortcut menu to display the **Graph Properties** dialog box.

4. On the **Plots** page, select **Sawtooth** from the top pull-down menu. In the **Colors** section, click the **Line** color box to display the color picker. Select a new line color.
5. Select **Sawtooth (Formula Result)** from the top pull-down menu.
6. Place a checkmark in the **Do not use waveform names for plot names** checkbox. This action lets you edit the labels on the graph.
7. In the **Name** text box, delete the current label and change the name of this plot to `Scaled Sawtooth`.
8. Click the **OK** button to save the current configuration and close the **Graph Properties** dialog box.
The plot color and plot legend change.
9. Reopen the **Graph Properties** dialog box and experiment with other properties of the graph. For example, on the **Scales** page, try disabling automatic scaling and changing the minimum and maximum value of the y-axis.
10. Click the **Cancel** button to avoid applying any changes you made while experimenting. If you want to keep the changes you made, click the **OK** button.
11. Save and close the VI.

Summary

The following topics are a summary of the main concepts you learned in this chapter.

New Dialog Box and Template VIs

The **New** dialog box contains many template VIs, including the ones used in this manual. The template VIs help you start building VIs for common measurements and other tasks. The template VIs include the Express VIs, functions, and front panel objects you need to get started building common measurement applications.

Use one of the following methods to access the **New** dialog box:

- Click the **New, VI from Template**, or **More** links in the **Getting Started** window after you launch LabVIEW.
- Select **File»New** from the menu bar of the **Getting Started** window, the front panel, or the block diagram.

Front Panel

The front panel is the user interface of a VI. You build the front panel by using controls and indicators, which are the interactive input and output terminals of the VI, respectively. Controls and indicators are located on the **Controls** palette.

Controls are knobs, push buttons, dials, and other input mechanisms. Controls simulate instrument input mechanisms and supply data to the block diagram of the VI.

Indicators are graphs, LEDs, and other displays. Indicators simulate instrument output mechanisms and display data the block diagram acquires or generates.

Block Diagram

The block diagram contains the graphical source code, also known as G code or block diagram code, for how the VI runs. The block diagram code uses graphical representations of functions to control the front panel objects. Front panel objects appear as icon terminals on the block diagram. Wires connect control and indicator terminals to Express VIs, VIs, and functions. Data flows through the wires in the following ways: from controls to VIs and functions, from VIs and functions to indicators, and from VIs and functions to other VIs and functions. The movement of data through the nodes on the block diagram determines the execution order of the VIs and functions. This movement of data is known as dataflow programming.

Front Panel and Block Diagram Tools

The Positioning tool appears when you move the cursor over an object in the front panel window or on the block diagram. The cursor becomes an arrow that you can use to select, position, and resize objects. The Wiring tool appears when you move the cursor over a terminal of a block diagram object. The cursor becomes a spool that you can use to connect objects on the block diagram through which you want data to flow.

Running and Stopping a VI

Running a VI executes the solution of the VI. Click the **Run** button or press the <Ctrl-R> keys to run a VI. The **Run** button changes to a darkened arrow to indicate the VI is running. You can stop a VI immediately by clicking the **Abort Execution** button. However, aborting a VI that uses external resources might leave the resources in an unknown state. Design the VIs you create with a stop button to avoid this problem. A stop button stops a VI after the VI completes its current iteration.

Express VIs

Use Express VIs located on the **Functions** palette for common measurement tasks. When you place an Express VI on the block diagram, the dialog box you use to configure that Express VI appears by default. Set the options in this configuration dialog box to specify how the Express VI behaves. You also can double-click an Express VI or right-click an Express VI and select **Properties** from the shortcut menu to display the configuration dialog box. If you wire data to an Express VI and run it, the Express VI displays real data in the configuration dialog box. If you close and reopen the Express VI, the VI displays sample data in the configuration dialog box until you run the VI again.

Express VIs appear on the block diagram as expandable nodes with icons surrounded by a blue field. You can resize an Express VI to display its inputs and outputs. The inputs and outputs you can display for the Express VI depend on how you configure the VI.

LabVIEW Documentation Resources

The *LabVIEW Help* contains information about LabVIEW programming concepts, step-by-step instructions for using LabVIEW, and reference information about LabVIEW VIs, functions, palettes, menus, tools, properties, methods, events, dialog boxes, and so on. The *LabVIEW Help* also lists the LabVIEW documentation resources available from National Instruments. To access help information for Express VIs, click the **Help** button in the configuration dialog box while you configure an Express VI. You also can access the *LabVIEW Help* by right-clicking a VI or function on the block diagram or on a pinned palette and selecting **Help** from the shortcut menu or by selecting **Help»LabVIEW Help**.

After you install a LabVIEW add-on such as a toolkit, module, or driver, the documentation for that add-on appears in the *LabVIEW Help* or appears in a separate help system you access by selecting **Help»Add-On Help**, where **Add-On Help** is the name of the separate help system for the add-on.

Property Dialog Boxes

Use property dialog boxes or shortcut menus to configure how controls and indicators appear or behave in the front panel window. Right-click a control or indicator on the front panel and select **Properties** from the shortcut menu to access the property dialog box for that object. You cannot access property dialog boxes for a control or indicator when a VI is running.

Shortcuts

This chapter introduced the following keyboard shortcuts.



Note The <Ctrl> key in shortcuts corresponds to the (**Mac OS X**) <Option> or <Command> key or (**Linux**) <Alt> key.

Shortcut	Function
<Ctrl-R>	Runs a VI.
<Ctrl-Z>	Undoes the last action.
<Ctrl-E>	Switches between the block diagram and the front panel window.
<Ctrl-S>	Saves a VI.

Customizing a VI

You can choose one of many LabVIEW template VIs to use as a starting point when building VIs. However, sometimes you need to build a VI for which a template is not available. This chapter teaches you how to build and customize a VI without using a template.

Building a VI from a Blank VI

In the following exercises, you will open a blank VI and add structures and Express VIs to the block diagram to build a new VI. You will build a VI that generates a signal, reduces the number of samples in the signal, and displays the resulting data in a front panel table. After you complete the exercises, the front panel of the VI will look similar to the front panel in Figure 2-1.



You can complete the exercises in this chapter in approximately 45 minutes.

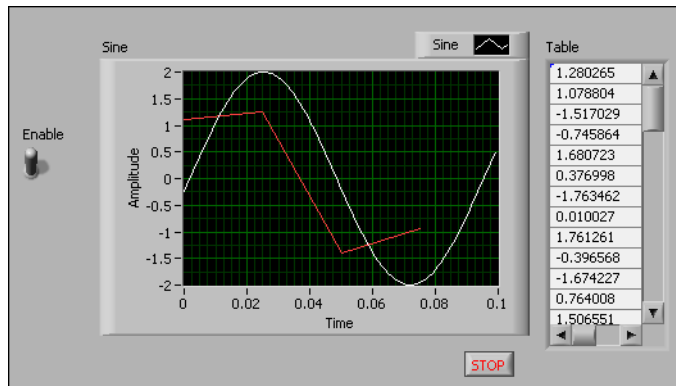

Figure 2-1. Front Panel of the Reduce Samples VI

Opening a Blank VI

If no template is available for the VI you want to build, you can start with a blank VI and add Express VIs to accomplish a specific task.

Complete the following steps to open a blank VI.

1. In the **Getting Started** window, click the **Blank VI** link in the **New** section or press the <Ctrl-N> keys to open a blank VI.

A blank front panel window and block diagram window appear.



Note You also can open a blank VI by selecting **File»New VI** or by selecting **File»New** and selecting **Blank VI** from the **Create New** list.

2. Display the block diagram.
3. If the **Functions** palette is not visible, right-click any blank space on the block diagram to display a temporary version of the **Functions** palette. Click the thumbtack, shown at left, in the upper left corner of the **Functions** palette to pin the palette so it is no longer temporary.



Adding an Express VI That Simulates a Signal

Complete the following steps to find the Express VI you want to use and add it to the block diagram.

1. Select **Help»Show Context Help** from the front panel or the block diagram to display the **Context Help** window, shown in Figure 2-2. You also can click the **Show Context Help Window** button, shown at left, on the front panel or block diagram toolbar to display the **Context Help** window.

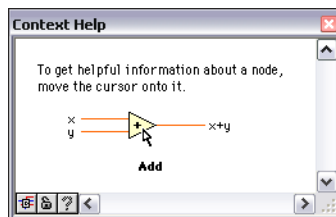

Figure 2-2. Context Help Window



Tip You also can press the <Ctrl-H> keys to display the **Context Help** window. **(Mac OS)** Press the <Command-Shift-H> keys.

2. On the **Functions** palette, select the **Express»Input** palette and move the cursor over one of the Express VIs on the **Input** palette.

When you move the cursor over a VI, the **Context Help** window displays information about that VI.

3. Use the information that appears in the **Context Help** window to find the Express VI that can simulate a sine wave signal.

Keep the **Context Help** window open. The context help provides useful information as you complete the rest of this exercise.

4. Select the Express VI that can simulate a sine wave signal and place it on the block diagram. The **Configure Simulate Signal** dialog box appears.

5. Move the cursor over the various options in the **Configure Simulate Signal** dialog box, such as **Frequency (Hz)** and **Amplitude**. Read the information that appears in the **Context Help** window.

6. Configure the Simulate Signal Express VI to generate a sine wave with a frequency of 10.7 and amplitude of 2.

The signal in the **Result Preview** window changes to reflect the configured sine wave.

7. Click the **OK** button to save the current configuration and close the **Configure Simulate Signal** dialog box.

8. Move the cursor over the Simulate Signal Express VI and read the information that appears in the **Context Help** window.

The **Context Help** window displays information about how you configured the Simulate Signal Express VI in addition to the standard context help description.

9. Save the VI as `Reduce_Samples.vi` in an easily accessible location.

Searching the Help and Modifying a Signal

Complete the following steps to use the *LabVIEW Help* to search for the Express VI that reduces the number of samples in a signal.

1. On the block diagram, move the cursor over the Simulate Signal Express VI to display the **Context Help** window and click the **Detailed help** link to display the *Simulate Signal* topic in the *LabVIEW Help*. You might have to enlarge or scroll down in the **Context Help** window to see the **Detailed help** link.

You also can access the *LabVIEW Help* by right-clicking a VI or function on the block diagram or on a pinned palette and selecting **Help** from the shortcut menu or by selecting **Help»LabVIEW Help**.

- Click the **Search** tab, enter `sample compression` in the **Type in the word(s) to search for** text box, and press the <Enter> key. You can place quotation marks around the phrase to search for the exact phrase. For example, you can enter "sample compression" to narrow the search results.

This word choice reflects what you want this Express VI to do—compress, or reduce, the number of samples in a signal.

You also can click the **Index** tab to search keywords and concepts.

- Double-click the **Sample Compression** topic in the search results to display the topic that describes the Sample Compression Express VI.
- After you read the description of the Express VI, click the **Add to the block diagram** button to place the Express VI on the cursor.
- Move the cursor to the block diagram.
- Add the Sample Compression Express VI to the block diagram to the right of the Simulate Signal Express VI.

When you know which item you want to add to the block diagram or front panel, you can use the **Quick Drop** dialog box to quickly find the item and add it to the block diagram or front panel. Select **Quick Drop** from the **View** menu to display this dialog box. You also can press the <Ctrl-Space> keys. (**Mac OS X**) Press the <Command-Shift-Space> keys.



Tip You can speed up the initial launch of the **Quick Drop** dialog box by enabling the **Load palettes during launch** radio button on the **Controls/Functions Palette** page of the **Options** dialog box. Selecting to load palettes while LabVIEW launches might slow down the launching of LabVIEW slightly.

- Configure the Sample Compression Express VI to reduce the signal by a factor of 25 using the mean of these values.
- Click the **OK** button to save the current configuration and close the **Configure Sample Compression** dialog box.
- Use the Wiring tool to wire the **Sine** output of the Simulate Signal Express VI to the **Signals** input of the Sample Compression Express VI.

Customizing a User Interface from the Block Diagram

In the previous exercises, you added controls and indicators to the front panel using the **Controls** palette. You also can create controls and indicators from the block diagram.

Complete the following steps to create controls and indicators from the block diagram.



1. On the block diagram, right-click the **Mean** output of the Sample Compression Express VI and select **Create»Numeric Indicator** from the shortcut menu to create a numeric indicator. A **Mean** indicator, shown at left, appears on the block diagram.
2. Right-click the **Mean** output of the Sample Compression Express VI and select **Insert Input/Output** from the shortcut menu to insert the **Enable** input.

In previous exercises, you learned to add inputs and outputs by expanding the Express VI using the down arrows. Using the shortcut menu is a different way to display and select the inputs and outputs of an Express VI.



3. Right-click the **Enable** input and select **Create»Control** from the shortcut menu to create a switch. A Boolean control, shown at left, appears on the block diagram.

Control terminals have a thicker border than indicator terminals. Also, an arrow appears on the right of the terminal if the terminal is a control, and an arrow appears on the left of the terminal if the terminal is an indicator.

4. Right-click the wire that connects the **Sine** output of the Simulate Signal Express VI to the **Signals** input of the Sample Compression Express VI and select **Create»Graph Indicator** from the shortcut menu.
5. Use the Wiring tool to wire the **Mean** output of the Sample Compression Express VI to the **Sine** graph indicator.

The Merge Signals function appears.

- Arrange the objects on the block diagram so they appear similar to Figure 2-3.

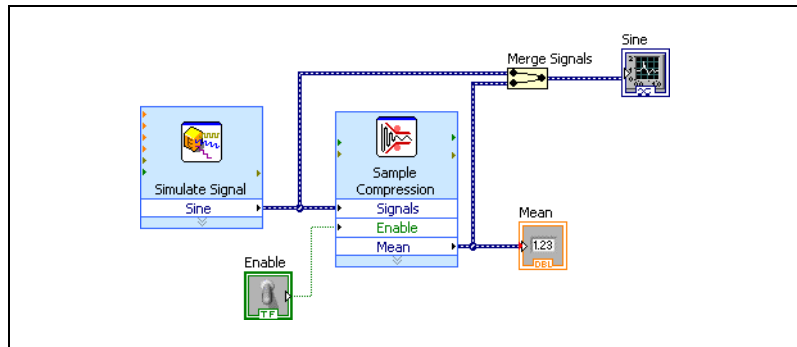

Figure 2-3. Block Diagram of the Reduce Samples VI

- Display the front panel.

The controls and indicators you added appear in the front panel with labels that correspond to the inputs and outputs from which you created the controls and indicators.



Note You might need to scroll or resize the front panel to see all controls and indicators.

- Save the VI.

Configuring a VI to Run Continuously until the User Stops It

In the current state, the VI runs once, generates one signal, and then stops running. To run the VI until a condition occurs, you can use a While Loop.

Complete the following steps to add a While Loop to the block diagram.

- Display the front panel and run the VI.

The VI runs once and then stops. The front panel does not have a stop button.

- Display the block diagram.

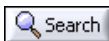

- Click the **Search** button, shown at left, on the **Functions** palette, and enter `while` in the text box. LabVIEW searches as you type the first few letters and displays any matches in the search results text box.

If there are objects with the same name, use the information in the brackets to the right of each object name to decide which object to select. Some objects are located on multiple palettes because you can use them for multiple applications.

4. Double-click **While Loop** <<Execution Control>> to display the **Execution Control** subpalette and temporarily highlight the While Loop on the subpalette.
5. Select the While Loop on the **Execution Control** palette.
6. Move the cursor to the upper left corner of the block diagram. Click and drag the cursor diagonally to enclose *all* the Express VIs and wires, as shown in Figure 2-4.

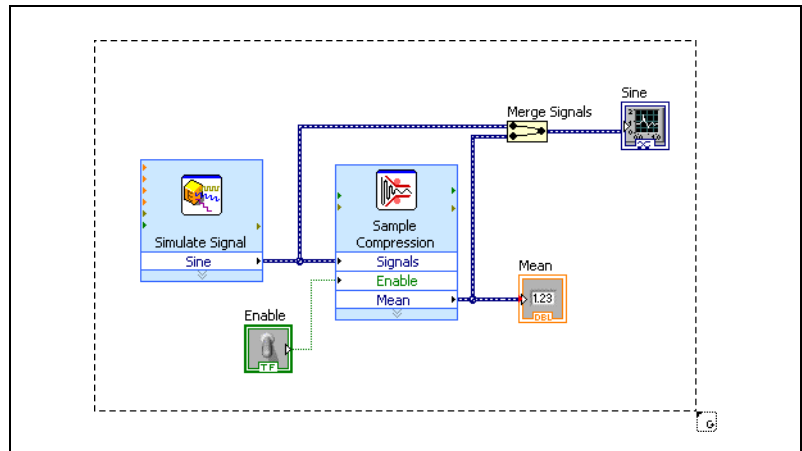
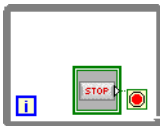

Figure 2-4. Placing the While Loop around the Express VIs

7. Release the mouse to place the While Loop around the Express VIs and wires.

The While Loop, shown at left, appears with a **STOP** button wired to the conditional terminal. This While Loop is configured to stop when the user clicks the **STOP** button.



8. Display the front panel and run the VI.
The VI now runs until you click the **STOP** button. A While Loop executes the VIs and functions inside the loop until the user clicks the **STOP** button.
9. Click the **STOP** button and save the VI.

Using the Error List Window

If a VI contains an indicator you do not want to use, you can delete it.

Complete the following steps to remove the **Mean** indicator from the front panel.



1. Display the front panel and move the cursor over the **Mean** indicator until the Positioning tool appears.
2. Click the **Mean** indicator, shown at left, to select it and press the <Delete> key.
3. Display the block diagram.

A wire appears as a dashed black line with a red **x** in the middle, shown at left. The dashed black line is a broken wire. The **Run** button, shown at left, appears broken to indicate the VI cannot run.

4. Click the broken **Run** button to display the **Error list** window.

The **Error list** window lists all errors in the VI and provides details about each error. You can use the **Error list** window to locate errors.

5. In the **errors and warnings** list, select the **wire: has loose ends** error and click the **Help** button to display more information about the error.



Tip You also can move the Wiring tool over a broken wire to display a tip strip that describes why the wire is broken. This information also appears in the **Context Help** window when you move the Wiring tool over a broken wire.

6. In the **errors and warnings** list, double-click the **wire: has loose ends** error to highlight the broken wire.
7. Press the <Ctrl-B> keys to delete the broken wire.
Pressing the <Ctrl-B> keys deletes *all* broken wires on the block diagram. You can press the <Delete> key to delete only the selected wire.
8. Select **View»Error List** to display the **Error list** window. No errors appear in the **errors and warnings** field.



Tip You also can press the <Ctrl-L> keys to display the **Error list** window.

9. Click the **Close** button to close the **Error list** window.
The **Run** button no longer appears broken.

Controlling the Speed of Execution

To plot the points on the waveform graph more slowly, you can add a time delay to the block diagram.

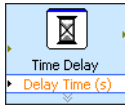

Complete the following steps to control the speed at which the VI runs.

1. On the block diagram, search for the Time Delay Express VI, shown at left, on the **Functions** palette and place it inside the While Loop.

You can use the Time Delay Express VI to control the execution rate of the VI.

2. Enter 0.25 in the **Time delay (seconds)** text box.

This time delay specifies how fast the loop runs. With a 0.25 second time delay, the loop iterates once every quarter of a second.

3. Click the **OK** button to save the current configuration and close the **Configure Time Delay** dialog box.

4. Display the front panel and run the VI.

5. Click the **Enable** switch and examine the change on the graph.

If the **Enable** switch is on, the graph displays the reduced signal. If the **Enable** switch is off, the graph does not display the reduced signal.

6. Click the **STOP** button to stop the VI.

Using a Table to Display Data

Complete the following steps to display a collection of mean values in a front panel table.

1. Display the front panel.
2. On the **Controls** palette search for the **Express Table** indicator and add it to the right of the waveform graph.
3. Display the block diagram.

LabVIEW wired the **Table** terminal to the Build Table Express VI.

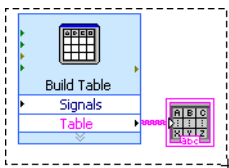

4. If the Build Table Express VI and the **Table** terminal are not selected already, click an open area on the block diagram to the left of the Build Table Express VI and the **Table** terminal. Drag the cursor diagonally until the selection rectangle encloses the Build Table Express VI and the **Table** terminal, shown at left.

A moving dashed outline, called a marquee, highlights the Build Table Express VI, the **Table** terminal, and the wire joining the two.

5. Drag the objects into the While Loop to the right of the Sample Compression Express VI.

If you drag objects near the border of the While Loop, the loop resizes to enclose the Build Table Express VI and the **Table** terminal after you add the object to the block diagram.

6. Use the Wiring tool to wire the **Mean** output of the Sample Compression Express VI to the **Signals** input of the Build Table Express VI.
7. The block diagram should appear similar to Figure 2-5.

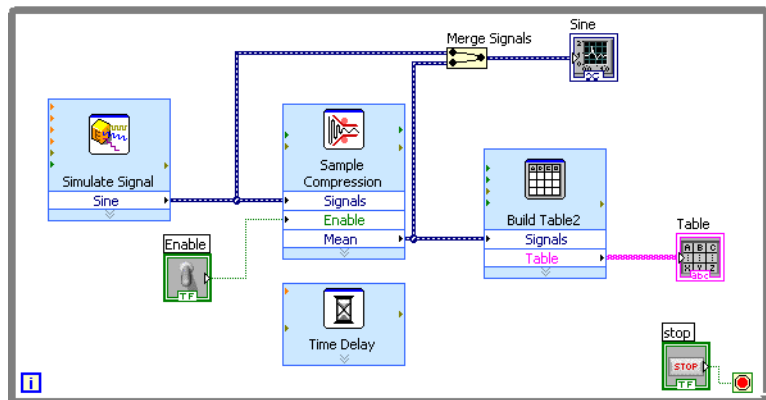

Figure 2-5. Block Diagram of the Reduce Samples VI

8. Display the front panel and arrange the controls and indicators as shown in Figure 2-1.
9. Run the VI.
10. Click the **Enable** switch.
If the **Enable** switch is on, the table displays the mean values of every 25 samples of the sine wave. If the **Enable** switch is off, the table does not record the mean values.
11. Stop the VI.
12. Experiment with properties of the table by using the **Table Properties** dialog box. For example, try changing the number of columns to one.
13. Save and close the VI.

Searching for Examples

To learn more about how you can use a certain VI, you can search for and view an example that uses the VI.

Complete the following steps to find and open an example that uses the Time Delay Express VI.

1. In the **Help** section of the **Getting Started** window, select **LabVIEW Help** to display the *LabVIEW Help*.
2. Click the **Search** tab. In the **Type in the word(s) to search for** text box enter `time delay express VI` and press the <Enter> key. **(Mac OS X and Linux)** Choose the **Full Text** option in the **Search Options** section of the **Search the LabVIEW Help** dialog box to narrow the search results.



Tip Refer to the **Using Help** book on the **Contents** tab in the *LabVIEW Help* for more information about searching help. **(Windows)** Before you search, you can narrow the search results by placing a checkmark in the **Search titles only** checkbox near the bottom of the help window. You also can use operators such as **AND**, **OR**, and **NEAR** in the **Type in the word(s) to search for** text box to narrow the search results.

3. **(Windows)** Click the **Location** column header to sort the search results by content type. *Reference* topics contain reference information about LabVIEW objects such as VIs, functions, palettes, menus, and tools. *How-To* topics contain step-by-step instructions for using LabVIEW. *Concept* topics contain information about LabVIEW programming concepts.
4. Double-click the **Time Delay Express VI** search result to display the reference topic that describes the Time Delay Express VI.
5. After you read the description of the Express VI, click the **Open example** button in the *Example* section near the bottom of the topic to open an example that uses the Time Delay Express VI.
6. Run the VI and move the vertical pointer slides. The amplitudes of Value A and B change as you move the vertical pointer slides.
7. Stop the VI.
8. Select **Window»Show Block Diagram** and read the block diagram comments.
9. Close the example VI and open the *LabVIEW Help* window.
10. Click the **Find related examples** button to open the NI Example Finder and display a list of examples similar to the example that uses this VI. The NI Example Finder searches among hundreds of

examples, including all installed examples and the examples located on the NI Developer Zone at ni.com/zone. You can modify an example to fit an application, or you can copy and paste from one or more examples into a VI that you create.



Note Always select **File»Save As** when you save a modified example to avoid overwriting the example program in the NI Example Finder.

You also can right-click a VI or function on the block diagram or on a pinned palette and select **Examples** from the shortcut menu to display a help topic with links to examples for that VI or function. To launch the NI Example Finder and browse or search examples, select **Help»Find Examples** or click the **Find Examples** link in the **Examples** section of the **Getting Started** window.



Note There is not an example for all VIs.

11. After you experiment with the NI Example Finder and the example VIs, close the NI Example Finder.

Summary

The following topics are a summary of the main concepts you learned in this chapter.

Using the LabVIEW Help Resources

In this chapter, you learned to use the help resources in the following ways:

- The **Context Help** window displays basic information about LabVIEW objects when you move the cursor over each object. Objects with context help information include VIs, functions, structures, palettes, dialog box components, and so on. To access the **Context Help** window, select **Help»Show Context Help** or press the <Ctrl-H> keys. (**Mac OS X**) Press the <Command-Shift-H> keys.
- When you move the cursor over an Express VI on the block diagram, the **Context Help** window displays a brief description of the Express VI and information about how you configured the Express VI.
- The *LabVIEW Help* contains detailed information about LabVIEW objects. To access the *LabVIEW Help* topic for an object, move the cursor over the object and click the **Detailed help** link in the **Context Help** window. You also can right-click an object on the block diagram or on a pinned palette and select **Help** from the shortcut menu.

- To navigate the *LabVIEW Help*, use the **Contents**, **Index**, and **Search** tabs. Use the **Contents** tab to get an overview of the topics and structure of the help. Use the **Index** tab to find a topic by keyword. Use the **Search** tab to search the help for a word or phrase.
- If you find an object in the *LabVIEW Help* you want to use, you can click an **Add to the block diagram** button to place the object on the block diagram.
- On the **Search** tab of the *LabVIEW Help*, use operators such as **AND**, **OR**, and **NEAR** to narrow the search results. To search for an exact phrase, place quotation marks around the phrase. Before you search, you also can narrow the search results by placing a checkmark in the **Search titles only** checkbox near the bottom of the help window.
- On the **Search** tab of the *LabVIEW Help*, you can click the **Location** column header above the list of search results to sort the results by content type. *Reference* topics contain reference information about LabVIEW objects such as VIs, functions, palettes, menus, and tools. *How-To* topics contain step-by-step instructions for using LabVIEW. *Concept* topics contain information about LabVIEW programming concepts.

Customizing the Block Diagram Code

You also can use many controls, indicators, Express VIs, and structures to build a VI. You can customize VIs in many ways. The following examples review a few common ways to customize VIs, including creating controls and indicators, configuring when VI stops, correcting broken wires, and displaying data in a table.

Creating Controls and Indicators

Create controls and indicators on the block diagram by right-clicking the Express VI input, output, or wire, selecting **Create** from the shortcut menu, and selecting among the available options. LabVIEW wires the control or indicator you created to the input, output, or wire you right-clicked.

Control terminals have a thicker border than indicator terminals. Also, an arrow appears on the right of the terminal if the terminal is a control, and an arrow appears on the left of the terminal if the terminal is an indicator.

Controlling When a VI Stops Running

Use a While Loop to run the code enclosed within the loop continually. A While Loop stops running when a stop condition occurs. After you place or move an object in a While Loop near the border, the loop resizes to add space for that object.

The **Execution Control** palette includes objects you can use to control the number of times a VI runs, as well as the speed at which the VI runs.

Errors and Broken Wires

The **Run** button appears broken when the VI you are creating or editing contains errors. If the **Run** button is still broken when you finish wiring the block diagram, the VI is broken and cannot run.

Click the broken **Run** button or select **View»Error List** to find out why a VI is broken. You can use the **Error list** window to locate errors. Click the **Help** button for more information about the error. Double-click the error in the **errors and warnings** field to highlight the problem causing the error.

A broken wire appears as a dashed black line with a red **x** in the middle. Broken wires occur for a variety of reasons, such as if you delete wired objects. The VI cannot run if the block diagram contains broken wires.

Move the Wiring tool over a broken wire to display a tip strip that describes why the wire is broken. This information also appears in the **Context Help** window when you move the Wiring tool over a broken wire. Right-click the wire and select **List Errors** from the shortcut menu to display the **Error list** window. Click the **Help** button for more information about why the wire is broken.

Displaying Data in a Table

The table indicator displays generated data. Use the Build Table Express VI to build a table of generated data.

Using the NI Example Finder

Use the NI Example Finder to browse or search examples installed on your computer or on the NI Developer Zone at ni.com/zone. These examples demonstrate how to use LabVIEW to perform a wide variety of test, measurement, control, and design tasks. Select **Help»Find Examples** or click the **Find Examples** link in the **Examples** section of the **Getting Started** window to launch the NI Example Finder.

Examples can show you how to use specific VIs or functions. You can right-click a VI or function on the block diagram or on a pinned palette and select **Examples** from the shortcut menu to display a help topic with links to examples for that VI or function. You can modify an example VI to fit an application, or you can copy and paste from one or more examples into a VI that you create.

Always select **File»Save As** when you save a modified example to avoid accidentally overwriting the example program in the NI Example Finder.

Shortcuts

This chapter introduced the following keyboard shortcuts.



Note The <Ctrl> key in these shortcuts corresponds to the **(Mac OS X)** <Option> or <Command> key or **(Linux)** <Alt> key.

Shortcut	Function
<Ctrl-N>	Opens a new, blank VI.
<Ctrl-H>	Shows or hides the Context Help window. (Mac OS X) Press the <Command-Shift-H> keys.
<Ctrl-Space>	Displays the Quick Drop dialog box. (Mac OS X) Press the <Command-Shift-Space> keys.
<Ctrl-B>	Deletes all broken wires in a VI.
<Ctrl-L>	Displays the Error list window.

Analyzing and Saving a Signal

LabVIEW includes a set of Express VIs that help you analyze signals. This chapter teaches you how to use LabVIEW to perform a basic analysis of a signal and how to save the analyzed data to a file.



Note The exercises in this chapter use Express VIs that are available only in the LabVIEW Full and Professional Development Systems.

Building an Analysis VI

In the following exercises, you will build a VI that generates a signal, filters the signal, indicates if the signal exceeds a certain limit, and records the data. After you complete the exercises, the front panel of the VI will look similar to the front panel in Figure 3-1.



You can complete the exercises in this chapter in approximately 40 minutes.

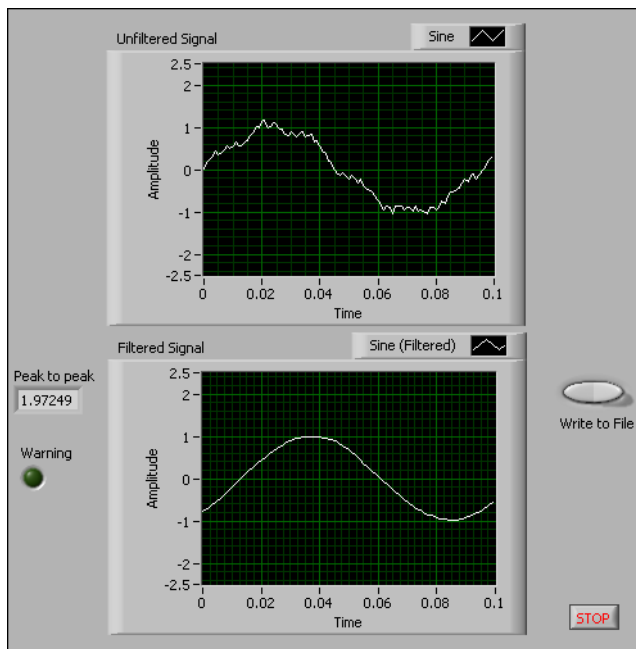

Figure 3-1. Front Panel of the Save Data VI

Modifying a VI Created from a Template

Complete the following steps to create a VI that generates, analyzes, and displays a signal.

1. In the **Getting Started** window, click **New** to display the **New** dialog box.
2. From the **Create New** list, select **VI»From Template»Tutorial (Getting Started)»Generate, Analyze, and Display**. This template VI simulates a signal and analyzes it for its root mean square (RMS) value.

3. Click the **OK** button or double-click the name of the template to create a VI from the template.
4. If the **Context Help** window is not visible, press the <Ctrl-H> keys to display the window. (**Mac OS X**) Press the <Command-Shift-H> keys.
5. Display the block diagram by pressing the <Ctrl-E> keys.

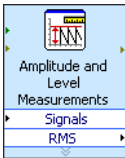

6. Move the cursor over the Amplitude and Level Measurements Express VI, shown at left.

The **Context Help** window displays information about the behavior of the Express VI.

Keep the **Context Help** window open. It will provide useful information as you complete the rest of this exercise.

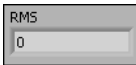

7. Display the front panel and remove the **RMS** indicator, shown at left.

You will not use the RMS functionality of the Amplitude and Level Measurements Express VI for this exercise. However, you can use the Generate, Analyze, and Display template VI with the RMS functionality in the future to reduce development time.

8. Display the block diagram and remove any broken wires that result from removing the **RMS** indicator. To remove all broken wires from the block diagram, you can press the <Ctrl-B> keys.
9. Then return to the front panel window and right-click the waveform graph indicator. Select **Properties** from the shortcut menu. The **Graph Properties** dialog box appears.
10. On the **Appearance** page, place a checkmark in the **Visible** checkbox in the **Label** section and enter `Unfiltered Signal` in the text box.
11. Click the **OK** button to save the configuration and close the **Graph Properties** dialog box.
12. Run the VI.
The signal appears in the graph.
13. Click the **STOP** button to stop the VI.

Adding a Signal

The Simulate Signal Express VI simulates a sine wave by default. You can customize the simulated signal by changing the options in the **Configure Simulate Signal** dialog box.

Complete the following steps to create an additional simulated signal that adds uniform white noise to the sine wave.

1. On the block diagram, use the Positioning tool to select the Simulate Signal Express VI.
Hold down the <Ctrl> key and click and drag to create an additional Simulate Signal Express VI on the block diagram. (**Mac OS X**) Hold down the <Option> key and drag. (**Linux**) You also can hold down the middle mouse button and drag.
2. Release the mouse button to place the copied Simulate Signal Express VI below the original Simulate Signal Express VI. LabVIEW updates the name of the copied Simulate Signal Express VI to Simulate Signal2.
3. Double-click the Simulate Signal2 Express VI to display the **Configure Simulate Signal** dialog box.
4. Select **Sine** from the **Signal type** pull-down menu.
5. Enter 60 in the **Frequency (Hz)** text box.
6. Enter 0.1 in the **Amplitude** text box.
7. Place a checkmark in the **Add noise** checkbox to add noise to the sine signal.
8. Select **Uniform White Noise** from the **Noise type** pull-down menu.
9. Enter 0.1 in the **Noise amplitude** text box.
10. Enter -1 in the **Seed number** text box.
11. In the **Timing** section, select the **Run as fast as possible** option.
12. In the **Signal Name** section, remove the checkmark from the **Use signal type name** checkbox.
13. Enter 60 Hz and Noise in the **Signal name** text box.

When you change the signal name in the **Configure Simulate Signal** dialog box, LabVIEW changes the name of the signal output on the block diagram. Changing the signal name makes it easier for you to identify the signal type when you view the Express VI on the block diagram.

The **Result Preview** section displays a random signal. The **Configure Simulate Signal** dialog box should appear similar to Figure 3-2.

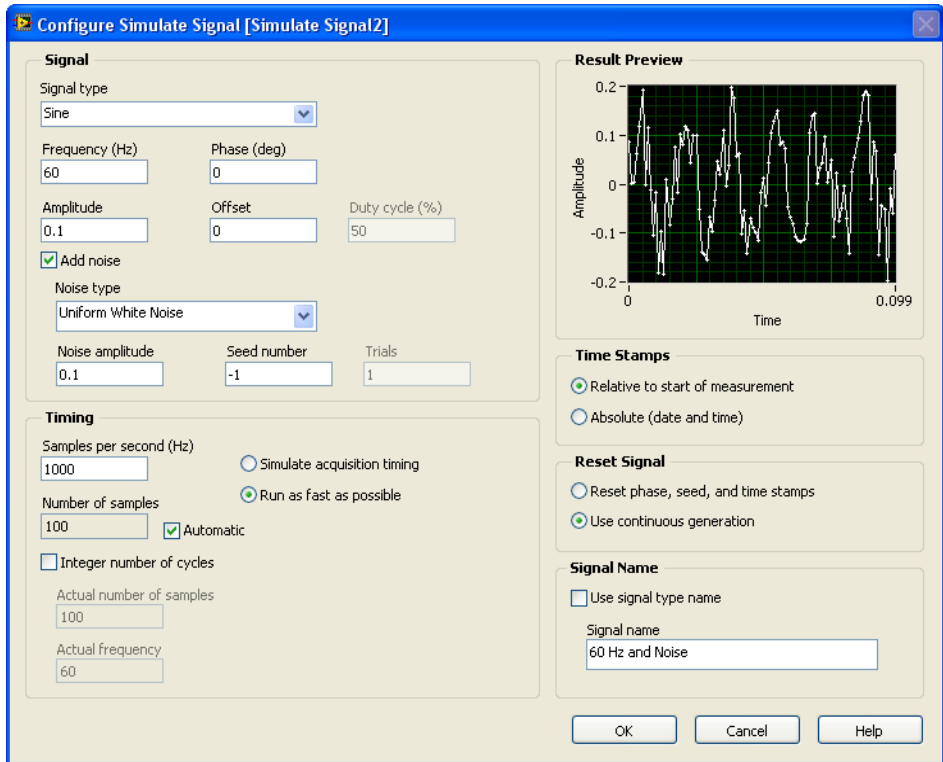

Figure 3-2. Configure Simulate Signal Dialog Box

14. Click the **OK** button to save the current configuration and close the **Configure Simulate Signal** dialog box.

Adding Two Signals

To add two signals together to create one signal, you can use the Formula Express VI. Rather than merging two signals on one graph, the Formula Express VI adds both signals together to create a single signal on the graph. You can use this Express VI to add noise to a signal.

Complete the following steps to add the **60 Hz and Noise** signal to the **Sine** signal.

1. In the block diagram window, triple-click the wire that connects the **Sine** output of the Simulate Signal Express VI to the **Signals** input of the Amplitude and Level Measurements Express VI and to the **Unfiltered Signal** indicator. Remove the wire.
2. On the **Functions** palette, click the **Search** button to search for the Formula Express VI, shown at left, and add it to the block diagram between the Simulate Signal Express VIs and the Amplitude and Level Measurements Express VI. The **Configure Formula** dialog box appears.

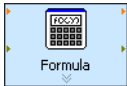

Note LabVIEW displays a folder glyph to the left of subpalettes in the search results and displays a light blue glyph to the left of Express VIs in the search results.

3. In the **Label** column, change the label for **X1** to **Sine** and the label for **X2** to **60 Hz and Noise**.
The Formula Express VI automatically enters the first input, **Sine**, in the **Formula** text box.
4. Click the **+** button and then the **X2** button to add **Sine** and **60 Hz and Noise** together in the **Formula** text box.
5. Click the **OK** button to save the current configuration and close the **Configure Formula** dialog box.
6. Use the Wiring tool to wire the **Sine** output of the Simulate Signal Express VI to the **Sine** input of the Formula Express VI.
7. Wire the **60 Hz and Noise** output of the Simulate Signal2 Express VI to the **60 Hz and Noise** input of the Formula Express VI.
8. Wire the **Result** output of the Formula Express VI to the **Unfiltered Signal** indicator and to the **Signals** input of the Amplitude and Level Measurements Express VI.
9. Display the front panel by pressing the <Ctrl-E> keys.
10. Run the VI.
The signal with added noise appears in the graph.
11. Click the **STOP** button to stop the VI.
12. Select **File>Save As** and save the VI as `Analysis.vi` in an easily accessible location.

Filtering a Signal

You can use the Filter Express VI to process signals through filters and windows.

Complete the following steps to configure the Filter Express VI to filter the signal using an infinite impulse response (IIR) filter.



1. Display the block diagram window and remove the wire that connects the **Result** output of the Formula Express VI to the **Signals** input of the Amplitude and Level Measurements Express VI.
2. Remove all broken wires that result from removing the wire.
3. Search for the Filter Express VI, shown at left, and add it to the block diagram between the Simulate Signal2 Express VI and the Amplitude and Level Measurements Express VI. The **Configure Filter** dialog box appears.
4. In the **Filter Specifications** section, change the **Cutoff Frequency (Hz)** to 25.
5. Click the **OK** button to save the configuration and close the **Configure Filter** dialog box.
6. Display the front panel.
7. Click the **Unfiltered Signal** waveform graph indicator and press the <Ctrl> key while you drag with the Positioning tool to create an additional waveform graph indicator.
8. Triple-click the **Unfiltered Signal 2** label above the new waveform graph indicator and enter `Filtered Signal` to change the label of the indicator. You also can change the label on the **Appearance** page of the **Graph Properties** dialog box.
9. On the block diagram, wire the **Result** output of the Formula Express VI to the **Signal** input of the Filter Express VI and to the **Unfiltered Signal** waveform graph indicator.
10. Wire the **Filtered Signal** output of the Filter Express VI to the **Signals** input of the Amplitude and Level Measurements Express VI and to the input of the **Filtered Signal** waveform graph indicator.

11. Select **File»Save**. The block diagram of the Analysis VI should appear similar to Figure 3-3.

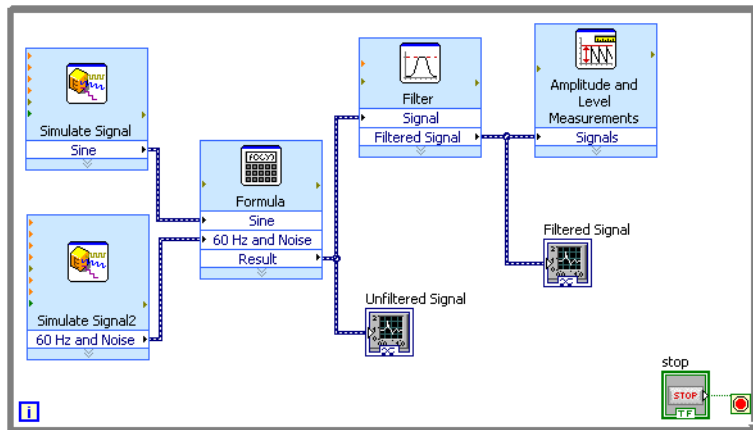

Figure 3-3. Block Diagram of the Analysis VI

Modifying the Appearance of Graphs

You can use the **Display Format** page of the **Graph Properties** dialog box to specify how the scales of the x-axis and y-axis appear on the graph.

Complete the following steps to change the format of the x-axis and y-axis of the **Unfiltered Signal** and **Filtered Signal** graphs.

1. In the front panel window, right-click the **Unfiltered Signal** graph indicator and select **Properties** from the shortcut menu. The **Graph Properties** dialog box appears.
2. On the **Display Format** page, select **Time (X-Axis)** from the top pull-down menu.
3. Select the **Default editing mode** option.
4. In the **Type** list, select **Automatic formatting**.
5. In the **Digits** field, enter 6 and select **Significant digits** from the **Precision Type** pull-down menu.
6. Place a checkmark in the **Hide trailing zeros** checkbox.
7. Select **Amplitude (Y-Axis)** from the top pull-down menu and repeat steps 3–6 so the y-axis configuration matches the x-axis configuration.
8. On the **Scales** page, select **Amplitude (Y-Axis)**.
9. Remove the checkmark from the **Autoscale** checkbox.

10. Enter -2.5 in the **Minimum** text box and 2.5 in the **Maximum** text box.
11. Click the **OK** button to save the configuration and close the **Graph Properties** dialog box.
12. Repeat steps 1–11 to configure the **Filtered Signal** graph indicator.
The x-axis and the y-axis on the **Unfiltered Signal** and **Filtered Signal** graph indicators change to reflect the new configuration.

Analyzing the Amplitude of a Signal

You can use the Amplitude and Level Measurements Express VI to analyze the voltage characteristics of a signal.

Complete the following steps to reconfigure the Express VI to measure the peak-to-peak amplitude values of the signal.

1. On the block diagram, double-click the Amplitude and Level Measurements Express VI to display the **Configure Amplitude and Level Measurements** dialog box.
2. In the **Amplitude Measurements** section, remove the checkmark from the **RMS** checkbox.
3. Place a checkmark in the **Peak to peak** checkbox. Peak to peak appears in the **Results** section with the corresponding value of the measurement.
4. Click the **OK** button to save the current configuration and close the **Configure Amplitude and Level Measurements** dialog box.

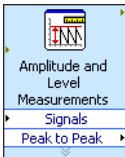

The **RMS** output of the Amplitude and Level Measurements Express VI changes to reflect the new **Peak to Peak** output, shown at left.

You will use the **Peak to Peak** output in a later exercise.

Controlling the Speed of Execution

To plot the points on the waveform graphs more slowly, you can add a time delay to the block diagram. A time delay slows the speed at which a VI runs.

Complete the following steps to control the speed at which the VI runs.

1. On the block diagram, search for the Time Delay Express VI.
2. Place the Time Delay Express VI inside the While Loop. The **Configure Time Delay** dialog box appears.
3. Enter 1.000 in the **Time delay (seconds)** text box and click the **OK** button.

4. Display the front panel and run the VI. The VI runs more slowly. The loop iterates once every second.
5. Stop the VI.

Another way to control the speed of the VI is to alter the rate of data acquisition. On the block diagram, double click the **Simulate Signal Express VI** to display the **Configure Simulate Signal** dialog box. Locate the **Timing** section in the dialog box. The **Timing** section contains a number of ways to alter the rate of data acquisition and the speed at which a VI runs.

For example, one of the default settings of the VI is **Simulate Acquisition Timing**. This means that the VI mimics the acquisition rate of a hardware device. You can select **Run as fast as possible** to display data more quickly. In the **Samples per second (Hz)** text box, the default value is 1000, while the default value in the **Number of Samples** text box is 100. This means that the VI will output 100 data points spanning 0.1 second. You can change these values to change the amount of data the VI displays, as well as the rate at which the VI displays the data.

Adding a Warning Light

If you want a visual cue to indicate when a value exceeds a specified limit, you can use a warning light.

Complete the following steps to add a warning light to the VI.

1. Display the **Controls** palette by right-clicking any blank space in the front panel window.
2. On the **Express** palette, select the **LEDs** palette.
3. Select the round LED indicator and add it to the front panel to the left of the waveform graphs.
4. Double-click the **Boolean** label above the LED and enter `Warning` to change the label of the LED.

You will use this LED in a later exercise to indicate when a value has exceeded its limit.

5. Select **File>Save As** to display the **Save As** dialog box.
6. Read the various dialog box options. Select the **Copy** and **Substitute copy for original** options to create a copy of the original VI and immediately edit the copy.
7. Click the **Continue** button and save the VI as `Warning Light.vi` in an easily accessible location.

Setting a Warning Level Limit

To specify the value at which you want the LED to light, use the Comparison Express VI.

Complete the following steps to compare the peak-to-peak value to a limit you set.

1. On the block diagram, search for the Comparison Express VI and place it to the right of the Amplitude and Level Measurements Express VI. The **Configure Comparison** dialog box appears.
2. In the **Compare Condition** section, select the **> Greater** option.
3. In the **Comparison Inputs** section, select **Value** and enter 2 in the **Value** numeric control to assign a constant value at which you want the LED to light.
4. Click the **OK** button to save the current configuration and close the **Configure Comparison** dialog box.

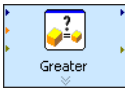

The name of the Comparison Express VI changes to reflect the operation of the Express VI, shown at left. **Greater** indicates that the Express VI does a greater than comparison.

5. Wire the **Peak to Peak** output of the Amplitude and Level Measurements Express VI to the **Operand 1** input of the Greater Express VI.
6. Move the cursor over the wire that connects the **Peak to Peak** output to the **Operand 1** input.
7. When the Positioning tool appears, right-click the wire that connects the **Peak to Peak** output to the **Operand 1** input and select **Create» Numeric Indicator** from the shortcut menu.



A **Peak to Peak** terminal, shown at left, appears on the block diagram. If the **Peak to Peak** terminal appears to be on top of the wires between the Express VIs, move the Express VIs and **Peak to Peak** terminal around to create more space. For example, move the **Peak to Peak** terminal into blank space above the Express VIs.



Tip You also can press <Ctrl> and drag a rectangle in open space to add more working space to the front panel or block diagram.

Warning the User

After you specify the values at which you want the LED to light, you must wire the LED to the Greater Express VI.

Complete the following steps to provide a visual cue when the peak-to-peak value of the signal exceeds a specified limit.

1. In the block diagram window, move the **Warning** terminal to the right of the Greater Express VI. Make sure the **Warning** terminal is inside the While Loop, as shown in Figure 3-4.

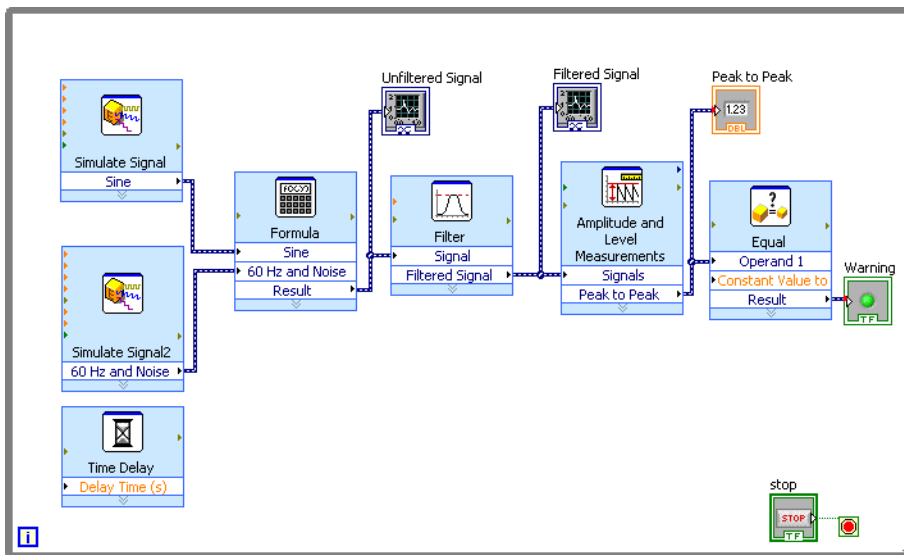

Figure 3-4. Block Diagram of the Warning Light VI

2. Wire the **Result** output of the Greater Express VI to the **Warning** terminal.

The block diagram should appear similar to Figure 3-4.



Note Red coercion dots appear automatically at the **Peak to Peak** and **Warning** input terminals to alert you that you wired two different data types together and LabVIEW converted the value passed into the node to a different representation. The block diagram places the coercion dots on the border of the terminal where the conversion takes place. For this exercise, the conversion does not affect how the VI runs. Refer to the *LabVIEW Help* for more information about coercion dots.

3. Display the front panel.
A numeric indicator labeled **Peak to Peak** appears in the front panel window. This indicator displays the peak-to-peak value of the signal.
4. Run the VI.
When the peak-to-peak value exceeds 2.0, the **Warning** indicator lights.
5. Click the **STOP** button to stop the VI.
6. Save the VI.

Configuring a VI to Save Data to a File

To store information about the data a VI generates, use the Write To Measurement File Express VI.

Complete the following steps to build a VI that saves peak-to-peak values and other information to a LabVIEW data file.

1. Search for the Write To Measurement File Express VI and add it to the block diagram below and to the right of the Amplitude and Level Measurements Express VI.

The **Configure Write To Measurement File** dialog box appears.

The **Filename** text box displays the full path to the output file, `test.lvm`. A `.lvm` file is a tab-delimited text measurement file you can open with a spreadsheet application or a text-editing application. LabVIEW saves data with up to six digits of precision in a `.lvm` file. LabVIEW saves the `.lvm` file in the default LabVIEW Data directory. LabVIEW installs the LabVIEW Data directory in the default file directory of the operating system.

When you want to view the data, use the file path displayed in the **Filename** text box to access the `test.lvm` file.

2. In the **Configure Write to Measurement File** dialog box, locate the **If a file already exists** section and select the **Append to file** option to write all the data to the `test.lvm` file without erasing any existing data in the file.
3. In the **Segment Headers** section, select the **One header only** option to create only one header in the file to which LabVIEW writes the data.
4. Enter the following text in the **File Description** text box: `Sample of peak to peak values`. LabVIEW appends the text you enter in this text box to the header of the file.
5. Click the **OK** button to save the current configuration and close the **Configure Write To Measurement File** dialog box.

Saving Data to a File

When you run the VI, LabVIEW saves the data to the `test.lvm` file.

Complete the following steps to generate the `test.lvm` file.

1. On the block diagram, wire the **Peak to Peak** output of the Amplitude and Level Measurements Express VI to the **Signals** input of the Write To Measurement File Express VI.
2. Select **File»Save As** and save the VI as `Save Data.vi` in an easily accessible location.
3. Display the front panel and run the VI.
4. Click the front panel **STOP** button.
5. To view the data you saved, open the `test.lvm` file in the LabVIEW Data directory with a spreadsheet or text-editing application.

The file has a header that contains information about the Express VI.

6. Close the file after you finish looking at it and return to the Save Data VI.

Adding a Button That Stores Data When Clicked

If you want to store only certain data points, you can configure the Write To Measurement File Express VI to save peak-to-peak values only when a user clicks a button.

Complete the following steps to add a button to the VI and configure how the button responds when a user clicks it.

1. Display the front panel and search the **Controls** palette for a rocker button. Select one of the rocker buttons and place it to the right of the waveform graphs.
2. Right-click the rocker button and select **Properties** from the shortcut menu to display the **Boolean Properties** dialog box.
3. Change the label of the button to `Write to File`.
4. On the **Operation** page of the **Boolean Properties** dialog box, select **Latch when pressed** from the **Button behavior** list.

Use the **Operation** page to specify how a button behaves when a user clicks it. To see how the button reacts to a click, click the button in the **Preview Selected Behavior** section.

5. Click the **OK** button to save the current configuration and close the **Boolean Properties** dialog box.
6. Save the VI.

Saving Data When Prompted by a User

Complete the following steps to build a VI that logs data to a file when the user clicks a button on the front panel.

1. In the block diagram window, double-click the Write To Measurement File Express VI to display the **Configure Write To Measurement File** dialog box.
2. Change the filename `test.lvm` in the **Filename** text box to `Selected Samples.lvm` to save the data to a different file.
3. Click the **OK** button to save the current configuration and close the **Configure Write To Measurement File** dialog box.
4. Right-click the **Signals** input of the Write To Measurement File Express VI and select **Insert Input/Output** from the shortcut menu to insert the **Comment** input.
5. Right-click the **Comment** input of the Write To Measurement File Express VI and select **Select Input/Output>Enable** from the shortcut menu to replace the **Comment** input with the **Enable** input.

The inputs and outputs of an Express VI appear in a predetermined order when you add new inputs and outputs. To select a specific input, you might need to add an input first, and then change the input to the specific one you want to use by right-clicking the input and selecting **Select Input/Output** from the shortcut menu.

6. Move the **Write to File** terminal to the left of the Write To Measurement File Express VI.
7. Wire the **Write to File** terminal to the **Enable** input of the Write To Measurement File Express VI.

The block diagram should appear similar to Figure 3-5.

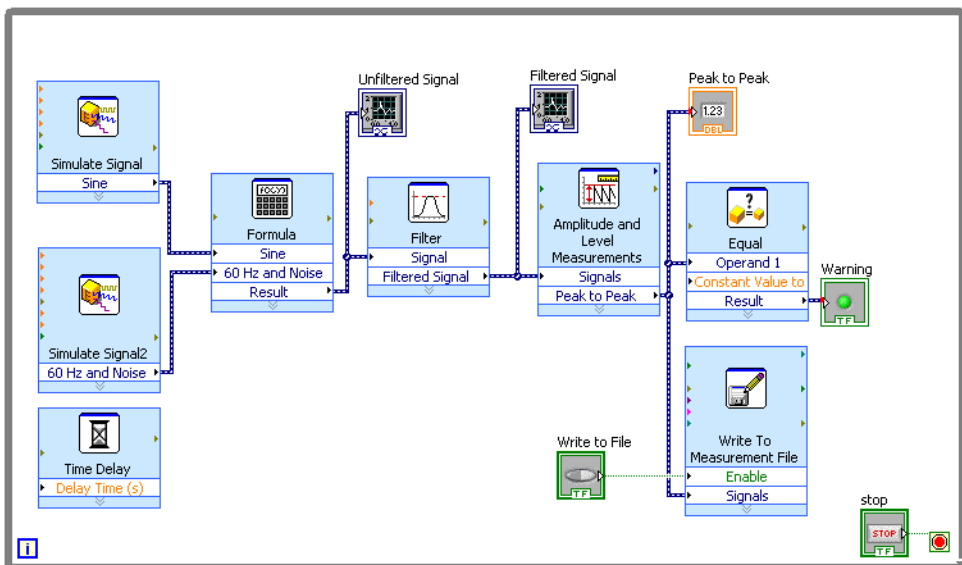

Figure 3-5. Block Diagram of the Save Data VI

Viewing Saved Data

Complete the following steps to view the data that you save to the Selected Samples.lvm file.

1. Display the front panel and run the VI. Click the **Write to File** button several times.
2. Click the **STOP** button.
3. Open the Selected Samples.lvm file with a spreadsheet or text-editing application.

The Selected Samples.lvm file differs from the test.lvm file. test.lvm recorded all the data generated by the Save Data VI, whereas Selected Samples.lvm recorded data only when you clicked the **Write to File** button.

4. Close the file after you finish looking at it.
5. Save and close the VI.

Summary

The following topics are a summary of the main concepts you learned in this chapter.

Controls and Indicators

You can configure front panel controls and indicators to perform tasks depending on what you want a VI to do. In this chapter, you learned to use controls and indicators in the following ways:

- You can build VIs that perform a task when certain conditions occur, such as displaying a warning light when a value exceeds a certain limit.
- You can build VIs that let users control when an Express VI executes by using buttons and the **Enable** input. You can configure the buttons to operate in one of six ways using the **Operation** page of the **Boolean Properties** dialog box.

Filtering Data

The Filter Express VI processes signals through filters and windows. You can use the Filter Express VI to remove noise from a signal.

Saving Data

The Write To Measurement File Express VI saves data that a VI generates and analyzes to a `.lvmm`, `.tdm`, or `.tdms` measurement file. The text-based measurement file (`.lvmm`) is a tab-delimited text file you can open with a spreadsheet application or a text-editing application. LabVIEW saves data with up to six digits of precision in a `.lvmm` file. In addition to the data an Express VI generates, the `.lvmm` file includes headers that contain information about the data, such as the date and time LabVIEW generated the data. The binary measurement file (`.tdm`) is a binary file that contains waveform data. Binary `.tdm` files provide higher accuracy for floating-point numbers, take up less space on disk, and perform faster than text-based measurement files (`.lvmm`). The TDM Streaming file (`.tdms`) is a binary file that provides faster writing performance than the `.tdm` file format and allows a simpler interface for defining properties.

LabVIEW installs the `LabVIEW Data` directory in the default file directory of the operating system to help you organize and locate the data files LabVIEW generates. Refer to the *LabVIEW Help* for more information about writing data to and reading data from `.lvmm` and `.tdm` files.

Hardware: Acquiring Data and Communicating with Instruments (Windows)

LabVIEW has the capability to connect and interact with a large number of hardware devices. This chapter introduces you to two Express VIs that make acquiring data and communicating with traditional, third-party instruments easier.

Hardware and Software Requirements

In the first exercise, you use the DAQ Assistant Express VI to acquire data with a DAQ device. This exercise requires data acquisition hardware and that you have NI-DAQmx installed. Refer to the *NI-DAQ Readme* for more information about platforms supported by NI-DAQmx software.

Refer to the **Taking Measurements** book on the **Contents** tab in the *LabVIEW Help* for information about acquiring data and communicating with instruments on all platforms.



Note With NI-DAQmx 7.4 or later you can create NI-DAQmx simulated devices in MAX. An NI-DAQmx simulated device is a software replica of a DAQ device. Refer to the *Measurement & Automation Explorer Help for NI-DAQmx* for detailed instructions on creating an NI-DAQmx simulated device that you can use to complete the first exercise.

In the second exercise, you use the NI Instrument Driver Finder to find and install instrument drivers. To use the Instrument Driver Finder, you must have internet access. In the second exercise, you also use the Instrument I/O Assistant Express VI to communicate with a traditional, third-party instrument. This exercise requires an instrument and that you have the Instrument I/O Assistant installed.

Refer to the **Controlling Instruments** book on the **Contents** tab in the *LabVIEW Help* for more information about communicating with instruments.



Note LabVIEW supports the DAQ and Instrument I/O Assistants used in this chapter on Windows only. The Instrument Driver Finder is available on Windows and Linux

Acquiring a Signal in NI-DAQmx

You will use the DAQ Assistant Express VI to create a task in NI-DAQmx. NI-DAQmx is a programming interface you can use to communicate with data acquisition devices. Refer to the **Getting Started with LabVIEW»Getting Started with DAQ»Taking an NI-DAQmx Measurement in LabVIEW** book on the **Contents** tab in the *LabVIEW Help* for information about additional ways to create NI-DAQmx tasks.

In the following exercises, you will create an NI-DAQmx task that continuously takes a voltage reading and plots the data on a waveform graph.



You can complete the exercises in this chapter in approximately 30 minutes.

Creating an NI-DAQmx Task

In NI-DAQmx, a task is a collection of one or more channels, which contains timing, triggering, and other properties. Conceptually, a task represents a measurement or generation you want to perform. For example, you can create a task to measure temperature from one or more channels on a DAQ device.

Complete the following steps to create and configure a task that reads a voltage level from a DAQ device.

1. Open a new, blank VI.
2. On the block diagram, display the **Functions** palette and select **Express»Input** to display the **Input** palette.
3. Select the DAQ Assistant Express VI, shown at left, on the **Input** palette and place it on the block diagram. The DAQ Assistant launches and the **Create New Express Task** dialog box appears.
4. Click **Acquire Signals»Analog Input** to display the **Analog Input** options.
5. Select **Voltage** to create a new voltage analog input task.

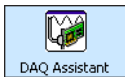

The dialog box displays a list of channels on each installed DAQ device. The number of channels listed depends on the number of channels you have on the DAQ device.

6. In the **Supported Physical Channels** list, select the physical channel to which the device connects the signal, such as **ai0**, and then click the **Finish** button. The DAQ Assistant opens a new dialog box, shown in Figure 4-1, that displays options for configuring the channel you selected to complete a task.

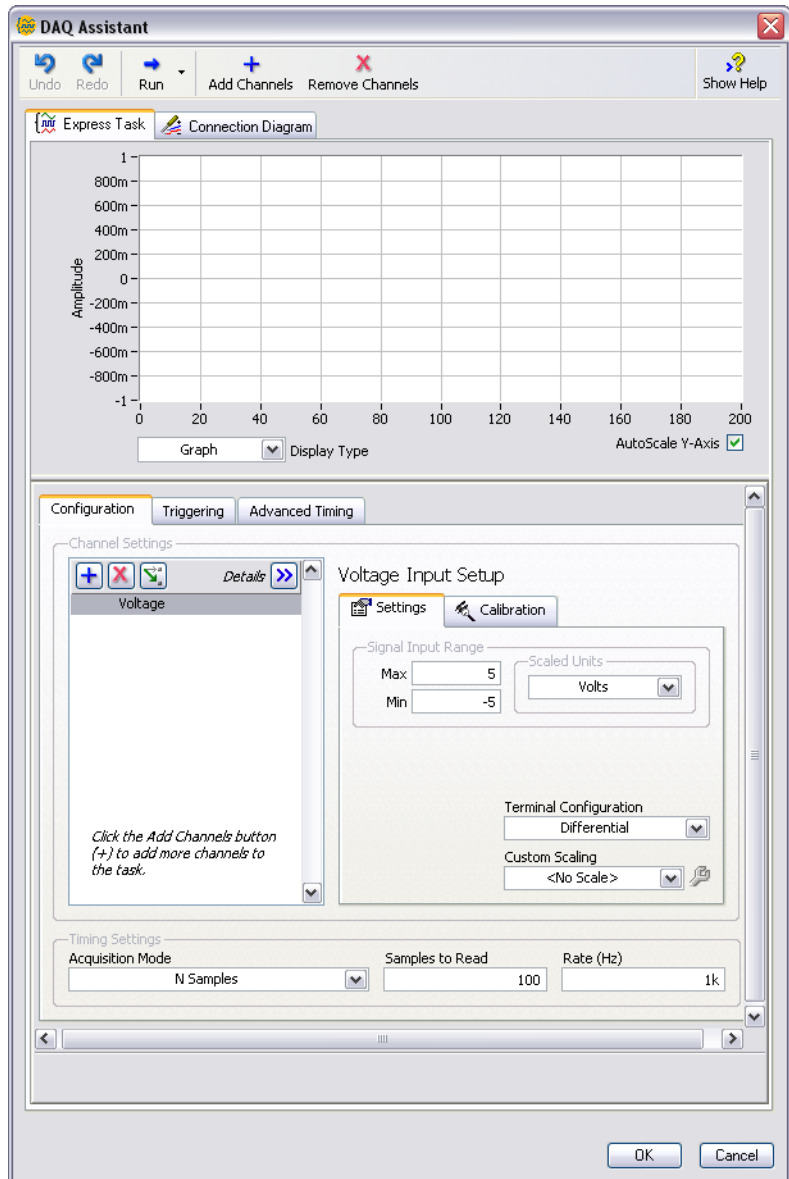

Figure 4-1. Configuring a Task Using the DAQ Assistant

7. In the DAQ Assistant dialog box select the **Configuration** tab and locate the **Voltage Input Setup** section.
8. Locate the **Settings** tab. In the **Signal Input Range** section enter 10 for the **Max** value and enter -10 for the **Min** value.

9. Locate the **Timing Settings** section at the bottom of the **Configuration** page. From the **Acquisition Mode** pull-down menu, select **N Samples**.
10. Enter a value of 1000 in the **Samples to Read** text box.
11. Click the **OK** button to save the current configuration and close the DAQ Assistant. LabVIEW builds the VI.
12. Save the VI as `Read Voltage.vi` in an easily accessible location.

Graphing Data from a DAQ Device

You can use the task you created in the previous exercise to graph the data acquired from a DAQ device.

Complete the following steps to plot the data from the channel on a waveform graph and change the name of the signal.

1. On the block diagram, right-click the **data** output and select **Create» Graph Indicator** from the shortcut menu.
2. Display the front panel and run the VI three or four times. Observe the waveform graph.
Voltage appears in the plot legend at the top of the waveform graph.
3. On the block diagram, right-click the DAQ Assistant Express VI and select **Properties** from the shortcut menu to open the DAQ Assistant.
4. Right-click **Voltage** in the list of channels and select **Rename** from the shortcut menu to display the **Rename a channel or channels** dialog box.



Tip You also can select the name of the channel and press the <F2> key to display the **Rename a channel or channels** dialog box.

5. In the **New Name** text box, enter `First Voltage Reading`, and click the **OK** button.
6. In the **DAQ Assistant** dialog box, click the **OK** button to save the current configuration and close the DAQ Assistant.
7. Display the front panel and run the VI.
First Voltage Reading appears in the waveform graph plot legend.
8. Save the VI.

Editing an NI-DAQmx Task

You can add a channel to the task so you can compare two separate voltage readings. You also can customize the task to acquire the voltage readings continuously.

Complete the following steps to add a new channel to the task and acquire data continuously.



1. In the block diagram window, double-click the DAQ Assistant Express VI to open the DAQ Assistant.
2. Click the **Add Channels** button, shown at left, and select **Voltage** to display the **Add Channels To Task** dialog box.
3. Select any unused physical channel in the **Supported Physical Channels** list, and click the **OK** button to return to the DAQ Assistant.
4. Rename the channel `Second Voltage Reading`.
5. In the **Timing Settings** section of the **Configuration** page, select **Continuous Samples** from the **Acquisition Mode** pull-down menu. When you set timing and triggering options in the DAQ Assistant, these options apply to all the channels in the list of channels.
6. Click the **OK** button to save the current configuration and close the DAQ Assistant. The **Confirm Auto Loop Creation** dialog box appears.
7. Click the **Yes** button. LabVIEW places a While Loop around the DAQ Assistant Express VI and the graph indicator on the block diagram. A stop button appears wired to the **stop** input of the DAQ Assistant Express VI. The **stopped** output of the Express VI is wired to the conditional terminal of the While Loop. The block diagram should appear similar to Figure 4-2.

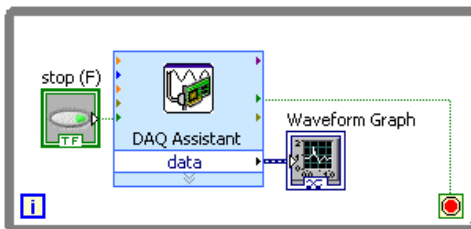

Figure 4-2. Block Diagram of the Read Voltage VI

If an error occurs or you click the **stop** button while the VI is running, the DAQ Assistant Express VI stops reading data and the **stopped** output returns a TRUE value and stops the While Loop.

Visually Comparing Two Voltage Readings

Because you have two voltage readings displayed on a graph, you can customize the plots to distinguish between the two.

Complete the following steps to customize the plot color of the front panel waveform graph.

1. Expand the plot legend of the waveform graph to display two plots.
2. Run the VI.
Two plots appear on the graph and the plot legend displays both plot names.
3. Click the icon that is to the right of **First Voltage Reading** in the plot legend and select **Color** from the shortcut menu. Using the color picker, select a color, such as yellow, so the plot is easy to read.
4. Change the plot color of **Second Voltage Reading**.
5. Stop the VI.
6. Save the VI.
7. Close the VI. The **Getting Started** window opens.

Communicating with an Instrument: Using Instrument Drivers and the Instrument I/O Assistant

An instrument driver is a set of software routines that control a programmable instrument. Each routine corresponds to a programmatic operation such as configuring, reading from, writing to, and triggering the instrument. Instrument drivers simplify instrument control and reduce test program development time by eliminating the need to learn the programming protocol for each instrument. Use an instrument driver for instrument control when possible. National Instruments provides thousands of instrument drivers for a wide variety of instruments.

In the following exercises, you will use instrument drivers and the Instrument I/O Assistant to communicate with an instrument. You must have instrument installed to fully complete the following exercises.



Note These exercises refer to traditional, third-party instruments. Refer to ni.com/modularinstruments for more information about communicating with NI modular instruments.

Getting Started with the Instrument Driver Finder

Use the NI Instrument Driver Finder to search for and install LabVIEW Plug and Play instrument drivers without leaving the LabVIEW development environment.



Tip You also can visit the NI Instrument Driver Network at ni.com/idnet to find a driver for an instrument, request a driver for an instrument, and read helpful articles and tutorials about using instrument drivers.

Complete the following steps to launch and configure the NI Instrument Driver Finder.

1. From the **Getting Started** window, select **Find Instrument Drivers** to launch the Instrument Driver Finder. You also can launch the Instrument Driver Finder by selecting **Help»Find Instrument Drivers** or **Tools»Instrumentation»Find Instrument Drivers**.
2. Click the **Login** button to sign-in using your NI.com profile. If you do not have an `ni.com` profile, skip to step 4.
3. If you already have an `ni.com` profile, enter your email address and password and click the **Login** button.
4. If you do not have an `ni.com` profile, select the **No, I need to create a profile** option and click the **Create Profile** button. This action launches a browser window where you can create an `ni.com` profile. After you create a profile, return to the Instrument Driver Finder window and login with your new information.

You are now ready to search for, install, and use instrument drivers with the Instrument Driver Finder.

Finding and Installing Instrument Drivers

Complete the following steps to search for and install an instrument driver using the Instrument Driver Finder.

1. On the **Configure Search** page, click the **Scan for Instruments** button. This action prompts the NI Instrument Driver Finder to search for connected instruments. All results display under the **Connected Instruments** folder in the left-hand sidebar. If you do not currently have an instrument connected, the Instrument Driver Finder will return a result that reads **<no connected instrument detected>**.
2. Expand the **Connected Instruments** folder to display the search results and select an instrument from the list.

3. Select a manufacturer from the **Manufacturer** pull-down menu, and enter any keywords in the **Additional Keywords** section. Then click the **Search** button.

A list of available instrument drivers appears on the **Search Results** page. The driver result for the most recent version of LabVIEW appears first in the list.

If your search does not return any results, a sidebar with search tips appears. Refer to the IDNet Web site at ni.com/idnet for more information about searching for instrument drivers.



Note The NI Instrument Driver Finder displays drivers only for LabVIEW 7.0. or later. If you need to download an older version of an instrument driver, go to the IDNet Web site at ni.com/idnet to search for and download instrument drivers compatible with older versions of LabVIEW.

4. Select the driver you want to install and then click the **Install** button.
After the driver downloads successfully, the **Download Success** window displays. This window contains options for exploring and using the new driver. After downloading, the new driver also appears in the **Configure Search** page under the **Installed Instrument Driver** folder.
5. Close the **Download Success** window to return to the **Configure Search** window.



Note You also can create your own instrument drivers. Refer to the **Controlling Instruments»Using Instrument Drivers** book on the **Contents** tab in the *LabVIEW Help* for more information about creating instrument drivers.

Using Instrument Drivers

After installing an instrument driver, you can explore example programs to learn more about using the instrument driver.

1. Double-click the newly installed instrument driver in the **Installed Instrument Driver** folder to display the **Start Using Instrument Driver** page.
2. The **Start Using Instrument Driver** page allows you to explore and customize the new driver. The following are recommendations to help you start using the new driver.
 - To view the new driver in the **Project Explorer** window, click the **Open Project** button. In the **Project Explorer** window, you can explore the VIs, folders, and supplemental files that make up the

driver. You also can access the driver readme file in the **Project Explorer** window.

- To view the driver's palette, click the **Open Palette** button. From the palette, you can select and add the driver VIs to the front panel and the block diagram.
- To view an example program, double-click on the listed example programs in the **Examples** section of the **Start Using Instrument Driver** page.



Note Not all drivers have all options available. For example, if a driver does not have a project file, the **Open Project** button appears dimmed. Refer to the IDNet Web site at ni.com/idnet for more information about all instrument drivers.

Selecting an Instrument Using the Instrument I/O Assistant

If a driver is not available for an instrument, you can use the Instrument I/O Assistant Express VI to communicate with the instrument.



Note You must have the Instrument I/O Assistant installed to use the Instrument I/O Assistant Express VI. You install the Instrument I/O Assistant from the National Instruments Device Drivers CD.

Complete the following steps to use the Instrument I/O Assistant Express VI to select an instrument.

1. Turn on the instrument you want to use. The instrument must be powered on to use the Instrument I/O Assistant Express VI.
2. Open a new VI and display the front panel window.
3. From the **Input** palette, select the Instrument I/O Assistant Express VI and add it to the block diagram. The **Instrument I/O Assistant** dialog box appears.
4. If the help is not visible to the right of the dialog box, click the **Show Help** button, shown at left, in the upper right corner of the **Instrument I/O Assistant** dialog box.

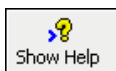

The help appears to the right of the dialog box. The top help window contains how-to information about using the Instrument I/O Assistant. The bottom help window provides context-sensitive help about components in the dialog box.

5. Click the **Select Instrument** link in the top help window and follow the instructions in the help window to select the instrument with which you want to communicate.



6. If necessary, configure the properties of the instrument.
7. If you want to minimize the help window, click the **Hide Help** button, shown at left, in the upper right corner of the **Instrument I/O Assistant** dialog box.

Acquiring and Parsing Information for an Instrument

After you select the instrument, you can send commands to the instrument to retrieve data. In this exercise, you will learn to use the Instrument I/O Assistant Express VI to acquire and parse identification information for an instrument.

Complete the following steps to communicate with the instrument.

1. In the **Instrument I/O Assistant** dialog box, click the **Add Step** button and click the **Query and Parse** step.
2. Enter `*IDN?` in the **Enter a command** text box.

`*IDN?` is a query that most instruments recognize. The response is an identification number string that describes the instrument. If the instrument does not accept this command, refer to the reference manual for the instrument for a list of commands the instrument does accept.

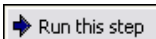

3. Click the **Run this step** button shown at left.

The Instrument I/O Assistant sends the command to the instrument, and the instrument returns its identification information.

4. Select **ASCII only** from the pull-down menu below the **Byte index** column of the response window to parse the instrument name as an ASCII string. You also can use the Instrument I/O Assistant to parse ASCII numbers and binary data.

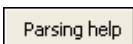

5. Click the **Parsing help** button, shown at left, in the **Instrument I/O Assistant** dialog box to display information about parsing data.
6. In the **ASCII representation** column of the response window, click the value you want to parse.

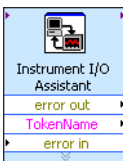

7. Enter a name for the token, or parsed data selection, in the **Token name** text box.

The name that you entered in the **Token name** text box is the output of the Instrument I/O Assistant Express VI, shown at left.

Wiring a Command to an Instrument

After you acquire data from the instrument, you can add an input parameter to an instrument command. The parameter becomes an input to the VI or function.

Complete the following steps to add a parameter to a command.

1. Click the **Add Step** button and click the **Write** step.
2. Enter *IDN? in the **Enter a command** text box.
3. Highlight the command in the **Enter a command** text box and click the **Add parameter** button to add a parameter to the command.
4. Enter a default value for the parameter in the **Test value** text box.
5. Enter a name for the parameter in the **Parameter name** text box. You use this name to reference the parameter in the application.
6. Click the **OK** button to save the current configuration and close the **Instrument I/O Assistant** dialog box.

Summary

The following topics are a summary of the main concepts you learned in this chapter.

DAQ Assistant Express VI

You can use the DAQ Assistant Express VI to interactively build measurement channels or tasks.

Add the DAQ Assistant Express VI to the block diagram to configure channels and tasks for use with NI-DAQmx for data acquisition. NI-DAQmx is a programming interface you can use to communicate with data acquisition devices. You can use the DAQ Assistant Express VI to control devices supported by NI-DAQmx.

Refer to the **Getting Started with LabVIEW»Getting Started with DAQ»Taking an NI-DAQmx Measurement in LabVIEW** book on the **Contents** tab in the *LabVIEW Help* for information about the DAQ Assistant.

Refer to the *NI-DAQ Readme* for information about devices supported by NI-DAQmx. If NI-DAQmx does not support the device you want to use, refer to the **Taking Measurements** book on the **Contents** tab in the *LabVIEW Help* for information about using Traditional NI-DAQ (Legacy) for data acquisition.

Tasks in NI-DAQmx

In NI-DAQmx, a task is a collection of one or more virtual channels with timing, triggering, and other properties. Conceptually, a task represents a measurement or generation you want to perform.

For example, you can configure a collection of channels for analog input operations. After you create a task, you can access the single task instead of configuring the channels individually to perform analog input operations. After you create a task, you can add or remove channels from that task.

Refer to the **Taking Measurements** book on the **Contents** tab in the *LabVIEW Help* for more information about channels and tasks.

Instrument Drivers

Use the NI Instrument Driver Finder to search for and install LabVIEW Plug and Play instrument drivers without leaving the LabVIEW development environment.

An instrument driver is a set of software routines that control a programmable instrument. Each routine corresponds to a programmatic operation such as configuring, reading from, writing to, and triggering the instrument. Use an instrument driver for instrument control when possible. National Instruments provides thousands of instrument drivers for a wide variety of instruments.

Refer to the **Controlling Instruments»Using Instrument Drivers** book on the **Contents** tab in the *LabVIEW Help* for more information about the Instrument Driver Finder.

You also can visit the NI Instrument Driver Network at ni.com/idnet to find a driver for an instrument, or you can create your own instrument drivers. Refer to the **Controlling Instruments»Using Instrument Drivers** book on the **Contents** tab in the *LabVIEW Help* for more information about creating instrument drivers.

Instrument I/O Assistant Express VI

If a driver is not available for an instrument, you can use the Instrument I/O Assistant Express VI to communicate with the instrument. You can use the Instrument I/O Assistant to communicate with message-based instruments and graphically parse the response. Start the Instrument I/O Assistant by adding the Instrument I/O Assistant Express VI to the block diagram or by double-clicking the Instrument I/O Assistant Express VI icon on the block diagram.

Refer to the *Instrument I/O Assistant Help* for information about communicating with an external device. Display the *Instrument I/O Assistant Help* by clicking the **Show Help** button in the **Instrument I/O Assistant** dialog box.

Using Other LabVIEW Features

The previous chapters in this manual introduce you to most of the LabVIEW features you need to build common measurement applications. As you familiarize yourself with the LabVIEW environment, you might find that you need to enhance VIs or that you need more fine-tuned control of the processes the VIs perform. This chapter introduces you to some of the concepts you should be familiar with as you start using other LabVIEW features. Refer to the **Fundamentals** book on the **Contents** tab in the *LabVIEW Help* for more information about these concepts. The **Concepts** books contain information about LabVIEW programming concepts, and the **How-To** books contain step-by-step instructions for using LabVIEW.

All Controls and Indicators

The controls and indicators located on the **Express** subpalette of the **Controls** palette are a subset of the complete set of built-in controls and indicators available in LabVIEW. On other subpalettes you can find all the controls and indicators that you can use to create the front panel. However, subpalettes other than the **Express** subpalette categorize controls and indicators by functionality instead of having a subpalette for controls and a subpalette for indicators.

For example, the top level of the **Express** subpalette has a **Numeric Controls** subpalette and a **Numeric Indicators** subpalette. On the **Modern** and **Classic** subpalettes, these controls and indicators are located on the **Numeric** subpalette because they are all numeric objects.

Click the **View** button on the pinned **Controls** palette and select **Change Visible Categories** from the shortcut menu to display the **Change Visible Categories** dialog box. Then place checkmarks in the checkboxes next to the categories you want to view on the **Controls** palette.

Refer to the **Fundamentals»Building the Front Panel** book on the **Contents** tab in the *LabVIEW Help* for more information about using the complete set of built-in controls and indicators available in LabVIEW.

All VIs and Functions

The Express VIs and structures located on the **Express** subpalette of the **Functions** palette are a small subset of the complete set of built-in VIs, functions, and structures available in LabVIEW.

Click the **View** button on the pinned **Functions** palette and select **Change Visible Categories** from the shortcut menu to display the **Change Visible Categories** dialog box. Then place checkmarks in the checkboxes next to the categories you want to view on the **Functions** palette.

LabVIEW uses colored icons to distinguish between functions, VIs, and Express VIs. Icons for functions have pale yellow backgrounds, most icons for VIs have white backgrounds, and icons for Express VIs appear surrounded by pale blue fields.

Express VIs appear on the block diagram as expandable nodes with icons surrounded by a blue field. Unlike Express VIs, most functions and VIs on the block diagram appear as icons rather than expandable nodes.

VIs

You can use an existing VI or a VI you create as a subVI. When you place a VI on the block diagram, the VI is a subVI. When you double-click a subVI, its front panel appears, rather than a dialog box in which you can configure options.

The icon for a VI appears in the upper right corner of the front panel and block diagram. This icon is the same as the icon that appears when you place the VI on the block diagram. You can use the default icon or create a custom icon using the **Icon Editor**.

Refer to the **Fundamentals»Creating VIs and SubVIs** book on the **Contents** tab in the *LabVIEW Help* for more information about creating VIs, configuring them as subVIs, and creating icons.

You also can save the configuration of an Express VI as a subVI. Refer to the **Fundamentals»Building the Block Diagram** book on the **Contents** tab in the *LabVIEW Help* for more information about creating subVIs from Express VIs.

Functions

Functions are the fundamental operating elements of LabVIEW. Unlike VIs, functions do not have front panels or block diagrams. Functions provide the basic building blocks for programming a VI, interfacing with hardware and software, and performing other essential tasks in LabVIEW. Refer to the **Fundamentals»Building the Block Diagram** book on the **Contents** tab in the *LabVIEW Help* for more information about functions.

Data Types

On the block diagram of a VI, the terminals for the front panel objects are different colors. The color and symbol of a terminal indicate the data type of the corresponding control or indicator. Colors also indicate the data types of wires, inputs, and outputs. The color of inputs and outputs of Express VIs indicate what type of data the input or output accepts or returns.

Data types indicate which objects, inputs, and outputs you can wire together. For example, a switch has a green border, so you can wire a switch to any Express VI input with a green label. A knob has an orange border, so you can wire a knob to any Express VI input with an orange label. However, you cannot wire a knob to an input with a green label. The wires you create are the same color as the terminal.



Express VIs generate and acquire data using the dynamic data type. The dynamic data type appears as a dark blue terminal, shown at left. Most Express VIs accept or return dynamic data. You can wire dynamic data to any indicator or input that accepts numeric, waveform, or Boolean data. Wire dynamic data to an indicator that can best present the data. Such indicators include graphs, charts, and numeric indicators.

Most other VIs and functions in LabVIEW do not accept dynamic data. To use a built-in VI or function to analyze or process dynamic data, you must convert the dynamic data to numeric, Boolean, waveform, or array data.

Use the Convert from Dynamic Data Express VI to convert dynamic data to numeric, Boolean, waveform, and array data for use with other VIs and functions. When you wire dynamic data to an array indicator, LabVIEW inserts the Convert from Dynamic Data Express VI on the block diagram.

Use the Convert to Dynamic Data Express VI to convert numeric, Boolean, waveform, and array data to dynamic data for use with Express VIs.

Refer to the **Fundamentals»Building the Block Diagram** book on the **Contents** tab in the *LabVIEW Help* for more information about data types.

When to Use Other LabVIEW Features

The Express VIs, structures, and controls and indicators located on the **Express** subpalettes of the **Controls** and **Functions** palettes provide the functionality you need to build common measurement applications. The following list describes the applications that require you to use the VIs, functions, structures, controls, and indicators located on subpalettes other than the **Express** subpalette.

- **Programmatically control properties and methods for the LabVIEW environment, VIs, and controls and indicators**—You can control programmatically how a VI behaves when it runs, set the appearance of a control or indicator, or control how the LabVIEW environment behaves. Refer to the **Fundamentals»Programmatically Controlling VIs** book on the **Contents** tab in the *LabVIEW Help* for more information about these features.
- **Call code written in text-based languages**—You can use LabVIEW to communicate with applications written in a text-based programming language, such as C or C++. Refer to the **Fundamentals»Calling Code Written in Text-Based Programming Languages** book on the **Contents** tab in the *LabVIEW Help* for more information about these features.
- **Communicate with VIs across a network**—You can call a VI that resides on another computer running LabVIEW. Refer to the **Fundamentals»Networking in LabVIEW** book on the **Contents** tab in the *LabVIEW Help* for more information about these features.
- **Share data within an application or across a network**—You can create configured software items called shared variables to share data among VIs or between locations on the block diagram that you cannot connect with wires. Refer to the **Fundamentals»Networking in LabVIEW** book on the **Contents** tab in the *LabVIEW Help* for more information about these features.
- **Publish VIs on the Web**—You can publish the front panel of any VI on the Web, where users can interact with the front panel. Refer to the **Fundamentals»Networking in LabVIEW** book on the **Contents** tab in the *LabVIEW Help* for more information about these features.
- **Save data to a variety of file formats**—In addition to the text-based measurement file format, you can create files that other applications can use, such as text files and spreadsheet files. Refer to the **Fundamentals»File I/O** book on the **Contents** tab in the *LabVIEW Help* for more information about these features.

- **Customize menus**—You can configure which menu items appear when a user runs a VI. You also can create custom menus. Refer to the **Fundamentals»Creating VIs and SubVIs** book on the **Contents** tab in the *LabVIEW Help* for more information about these features.
- **Use LabVIEW projects**—You can use projects to group together LabVIEW files and files not specific to LabVIEW, create build specifications, and deploy or download files to multiple targets from one location. You must use a project to build applications and shared libraries. You also must use a project to work with an RT, FPGA, PDA, Touch Panel, DSP, or embedded target. Refer to the specific module documentation for more information about using projects with these targets. Refer to the **Fundamentals»Working with Projects and Targets** book on the **Contents** tab in the *LabVIEW Help* for more information about using LabVIEW projects.
- **Access other Windows applications**—You can use LabVIEW as a .NET or ActiveX client to access the objects, properties, methods, and events associated with .NET server or ActiveX applications. Refer to the **Fundamentals»Windows Connectivity** book on the **Contents** tab in the *LabVIEW Help* for more information about these features.
- **Write mathematical formulas, equations, and scripts**—You can use various nodes to perform mathematical operations on the block diagram. You also can use the LabVIEW MathScript text-based language to write mathematical functions and scripts. Refer to the **Fundamentals»Formulas and Equations** book on the **Contents** tab in the *LabVIEW Help* for more information about these features.



Technical Support and Professional Services

Visit the following sections of the award-winning National Instruments Web site at ni.com for technical support and professional services:

- **Support**—Technical support at ni.com/support includes the following resources:
 - **Self-Help Technical Resources**—For answers and solutions, visit ni.com/support for software drivers and updates, a searchable KnowledgeBase, product manuals, step-by-step troubleshooting wizards, thousands of example programs, tutorials, application notes, instrument drivers, and so on. Registered users also receive access to the NI Discussion Forums at ni.com/forums. NI Applications Engineers make sure every question submitted online receives an answer.
 - **Standard Service Program Membership**—This program entitles members to direct access to NI Applications Engineers via phone and email for one-to-one technical support as well as exclusive access to on demand training modules via the Services Resource Center. NI offers complementary membership for a full year after purchase, after which you may renew to continue your benefits.

For information about other technical support options in your area, visit ni.com/services, or contact your local office at ni.com/contact.

- **Training and Certification**—Visit ni.com/training for self-paced training, eLearning virtual classrooms, interactive CDs, and Certification program information. You also can register for instructor-led, hands-on courses at locations around the world.
- **System Integration**—If you have time constraints, limited in-house technical resources, or other project challenges, National Instruments Alliance Partner members can help. To learn more, call your local NI office or visit ni.com/alliance.

If you searched ni.com and could not find the answers you need, contact your local office or NI corporate headquarters. Phone numbers for our worldwide offices are listed at the front of this manual. You also can visit the Worldwide Offices section of ni.com/niglobal to access the branch office Web sites, which provide up-to-date contact information, support phone numbers, email addresses, and current events.

Glossary

A

automatic scaling Ability of scales to adjust to the range of plotted values. On graph scales, autoscaling determines maximum and minimum scale values.

B

block diagram Pictorial description or representation of a program or algorithm. The block diagram consists of executable icons called nodes and wires that carry data between the nodes. The block diagram is the source code for the VI. The block diagram resides in the block diagram window of the VI.

Boolean controls and indicators Front panel objects to manipulate and display Boolean (TRUE or FALSE) data.

broken **Run** button Button that replaces the **Run** button when a VI cannot run because of errors.

broken VI VI that cannot run because of errors; signified by a broken arrow in the broken **Run** button.

C

channel	<p>1. Physical—A terminal or pin at which you can measure or generate an analog or digital signal. A single physical channel can include more than one terminal, as in the case of a differential analog input channel or a digital port of eight lines. A counter also can be a physical channel, although the counter name is not the name of the terminal where the counter measures or generates the digital signal.</p> <p>2. Virtual—A collection of property settings that can include a name, a physical channel, input terminal connections, the type of measurement or generation, and scaling information. You can define NI-DAQmx virtual channels outside a task (global) or inside a task (local). Configuring virtual channels is optional in Traditional NI-DAQ (Legacy) and earlier versions, but is integral to every measurement you take in NI-DAQmx. In Traditional NI-DAQ (Legacy), you configure virtual channels in MAX. In NI-DAQmx, you can configure virtual channels either in MAX or in your program, and you can configure channels as part of a task or separately.</p> <p>3. Switch—A switch channel represents any connection point on a switch. It can be made up of one or more signal wires (commonly one, two, or four), depending on the switch topology. A virtual channel cannot be created with a switch channel. Switch channels may be used only in the NI-DAQmx Switch functions and VIs.</p>
checkbox	Small square box in a dialog box which you can select or clear. Checkboxes generally are associated with multiple options that you can set. You can select more than one checkbox.
conditional terminal	Terminal of a While Loop that contains a Boolean value that determines if the VI performs another iteration.
Context Help window	Window that displays basic information about LabVIEW objects when you move the cursor over each object. Objects with context help information include VIs, functions, constants, structures, palettes, properties, methods, events, and dialog box components.
control	Front panel object for entering data to a VI interactively or to a subVI programmatically, such as a knob, push button, or dial.
Controls palette	Palette that contains front panel controls, indicators, and decorative objects.
current VI	VI whose front panel, block diagram, or Icon Editor is the active window.

D

DAQ	<i>See</i> data acquisition (DAQ).
DAQ Assistant	A graphical interface for configuring measurement tasks, channels, and scales.
DAQ device	A device that acquires or generates data and can contain multiple channels and conversion devices. DAQ devices include plug-in devices, PCMCIA cards, and DAQPad devices, which connect to a computer USB or IEEE 1394 port. SCXI modules are considered DAQ devices.
data acquisition (DAQ)	<ol style="list-style-type: none">1. Acquiring and measuring analog or digital electrical signals from sensors, acquisition transducers, and test probes or fixtures.2. Generating analog or digital electrical signals.
data flow	Programming system that consists of executable nodes that execute only when they receive all required input data. The nodes produce output data automatically when they execute. LabVIEW is a dataflow system. The movement of data through the nodes determines the execution order of the VIs and functions on the block diagram.
data type	Format for information. In LabVIEW, acceptable data types for most VIs and functions are numeric, array, string, Boolean, path, refnum, enumeration, waveform, and cluster.
default	Preset value. Many VI inputs use a default value if you do not specify a value.
device	An instrument or controller you can access as a single entity that controls or monitors real-world I/O points. A device often is connected to a host computer through some type of communication network. <i>See also</i> DAQ device and measurement device .
drag	To use the cursor on the screen to select, move, copy, or delete objects.
driver	Software that controls a specific hardware device, such as a DAQ device.
dynamic data type	Data type used by Express VIs that includes the data associated with a signal and attributes that provide information about the signal, such as the name of the signal or the date and time LabVIEW acquired the data. Attributes specify how the signal appears on a graph or chart.

E

Error list window	Window that displays errors and warnings occurring in a VI and in some cases recommends how to correct the errors.
error message	Indication of a software or hardware malfunction or of an unacceptable data entry attempt.
Express VI	A subVI designed to aid in common measurement tasks. You configure an Express VI using a configuration dialog box.

F

For Loop	Iterative loop structure that executes its subdiagram a set number of times. Equivalent to text-based code: <code>For i = 0 to n - 1, do...</code>
front panel	Interactive user interface of a VI. Front panel appearance imitates physical instruments, such as oscilloscopes and multimeters.
function	Built-in execution element, comparable to an operator, function, or statement in a text-based programming language.
Functions palette	Palette that contains VIs, functions, block diagram structures, and constants.

G

General Purpose Interface Bus	GPIB. Synonymous with HP-IB. The standard bus used for controlling electronic instruments with a computer. Also called IEEE 488 bus because it is defined by ANSI/IEEE Standards 488-1978, 488.1-1987, and 488.2-1992.
graph	2D display of one or more plots. A graph receives and plots data as a block.

I

I/O	Input/Output. The transfer of data to or from a computer system involving communications channels, operator input devices, and/or data acquisition and control interfaces.
icon	Graphical representation of a node on a block diagram.
indicator	Front panel object that displays output, such as a graph or LED.
instrument driver	A set of high-level functions that control and communicate with instrument hardware in a system.
Instrument I/O Assistant	Add-on launched from the Instrument I/O Assistant Express VI that communicates with message-based instruments and graphically parses the response.

L

label	Text object used to name or describe objects or regions on the front panel or block diagram.
LabVIEW	Laboratory Virtual Instrument Engineering Workbench. LabVIEW is a graphical programming language that uses icons instead of lines of text to create programs.
LED	Light-emitting diode.
legend	Object a graph or chart owns to display the names and plot styles of plots on that graph or chart.

M

MAX	<i>See</i> Measurement & Automation Explorer.
Measurement & Automation Explorer	The standard National Instruments hardware configuration and diagnostic environment for Windows.

measurement device	DAQ devices such as the E Series multifunction I/O (MIO) devices, SCXI signal conditioning modules, and switch modules.
menu bar	Horizontal bar that lists the names of the main menus of an application. The menu bar appears below the title bar of a window. Each application has a menu bar that is distinct for that application, although some menus and commands are common to many applications.

N

NI-DAQ	Driver software included with all NI DAQ devices and signal conditioning components. NI-DAQ is an extensive library of VIs and ANSI C functions you can call from an application development environment (ADE), such as LabVIEW, to program an NI measurement device, such as the M Series multifunction I/O (MIO) DAQ devices, signal conditioning modules, and switch modules.
NI-DAQmx	The latest NI-DAQ driver with new VIs, functions, and development tools for controlling measurement devices. The advantages of NI-DAQmx over earlier versions of NI-DAQ include the DAQ Assistant for configuring channels and measurement tasks for your device for use in LabVIEW, LabWindows™/CVI™, and Measurement Studio; NI-DAQmx simulation for most supported devices for testing and modifying applications without plugging in hardware; and a simpler, more intuitive API for creating DAQ applications using fewer functions and VIs than earlier versions of NI-DAQ.
node	Program execution element. Nodes are analogous to statements, operators, functions, and subroutines in text-based programming languages. On a block diagram, nodes include functions, structures, and subVIs.
numeric controls and indicators	Front panel objects to manipulate and display numeric data.

O

object	Generic term for any item on the front panel or block diagram, including controls, indicators, structures, nodes, wires, and imported pictures.
Operating tool	Tool to enter data into controls or to operate them.

P

palette	Displays objects or tools you can use to build the front panel or block diagram.
plot	Graphical representation of an array of data shown either on a graph or a chart.
Positioning tool	Tool to move and resize objects.
project	A collection of LabVIEW files and files not specific to LabVIEW that you can use to create build specifications and deploy or download files to targets.
Project Explorer window	Window in which you can create and edit LabVIEW projects.
Properties dialog boxes	Dialog boxes accessed from the shortcut menu of a control or indicator that you can use to configure how the control or indicator appears in the front panel window.
pull-down menus	Menus accessed from a menu bar. Pull-down menu items are usually general in nature.
PXI	PCI eXtensions for Instrumentation. A modular, computer-based instrumentation platform.

R

RMS	Root Mean Square.
-----	-------------------

S

sample	Single analog or digital input or output data point.
scale	Part of graph, chart, and some numeric controls and indicators that contains a series of marks or points at known intervals to denote units of measure.
shortcut menu	Menu accessed by right-clicking an object. Menu items pertain to that object specifically.

string	Representation of a value as text.
structure	Program control element, such as a Flat Sequence structure, Stacked Sequence structure, Case structure, For Loop, While Loop, or Timed Loop.
subpalette	Palette that you access from another palette that is above the subpalette in hierarchy.
subVI	VI used on the block diagram of another VI. Comparable to a subroutine.

T

task	A collection of one or more channels, timing, triggering, and other properties in NI-DAQmx. A task represents a measurement or generation you want to perform.
template VI	VI that contains common controls and indicators from which you can build multiple VIs that perform similar functions. Access template VIs from the New dialog box.
terminal	Object or region on a node through which data pass.
tip strip	Small yellow text banners that identify the terminal name and make it easier to identify terminals for wiring.
tool	Special cursor to perform specific operations.
toolbar	Bar that contains command buttons to run and debug VIs.
Traditional NI-DAQ (Legacy)	An older driver with outdated APIs for developing data acquisition, instrumentation, and control applications for older National Instruments DAQ devices. You should use Traditional NI-DAQ (Legacy) only in certain circumstances. Refer to the <i>NI-DAQ Readme</i> for more information about when to use Traditional NI-DAQ (Legacy), including a complete list of supported devices, operating systems, and application software and language versions.

V

VI	<i>See</i> virtual instrument (VI).
virtual instrument (VI)	Program in LabVIEW that models the appearance and function of a physical instrument.
VXI	VME eXtensions for Instrumentation (bus).

W

waveform	Multiple voltage readings taken at a specific sampling rate.
waveform chart	Indicator that plots data points at a certain rate.
While Loop	Loop structure that repeats a section of code until a condition occurs.
wire	Data path between nodes.
Wiring tool	Tool to define data paths between terminals.

Index

A

- acquiring
 - information for instruments, 4-11
 - signals, 4-2
- Acquiring a Signal VI block diagram (figure), 1-14
- adding
 - See also* creating
 - channels to tasks, 4-6
 - controls from the block diagram, 2-5
 - controls to the front panel, 1-6
 - graph indicators, 2-5
 - inputs to Express VIs, 1-9, 2-5, 3-15
 - multiple signals, 3-5
 - numeric indicators, 2-5
 - signals, 3-4
 - visual cues on front panel, 3-10
 - warning lights, 3-10
- Amplitude and Level Measurements Express VI, 3-3
 - analyzing voltage, 3-9
- analyzing signals, 3-9
- applications
 - building, 5-5
 - communicating with across networks, 5-4
- Arithmetic & Comparison palette, 1-12

B

- blank VIs, 2-2
- block diagram, 1-6, 1-19
 - customizing, 2-13
 - indicators, 3-17
 - placing objects from help, 2-13
 - showing, 1-8

- broken
 - Run button, 2-8
 - wires, 2-8, 2-14
- Build Table Express VI, 2-9
- building
 - applications, 5-5
 - shared libraries, 5-5
 - VIs, 1-2
- buttons
 - adding, 3-14
 - Run, 1-6

C

- calling code from text-based languages, 5-4, 5-5
- changing signal types, 1-8
- channels, 4-2
 - adding to tasks, 4-6
 - renaming, 4-5
- communicating
 - with instruments, 4-7
 - with LabVIEW applications across networks, 5-4
- Comparison Express VI, 3-11
- configuration dialog boxes, 1-20
- configuring
 - controls, 1-21
 - indicators, 1-21
- Context Help window, 2-12
 - button, 2-2, 3-3
 - displaying configuration of Express VIs, 3-3
 - displaying errors, 2-14
 - figure, 2-2
 - showing, 2-2

- controlling
 - execution speed, 2-9
 - VIs programmatically, 5-4
 - controls, 1-19, 3-17
 - adding from the block diagram, 2-5
 - adding to the front panel, 1-6
 - configuring, 1-21
 - creating, 2-5, 2-13
 - customizing, 1-16
 - data types, 5-3
 - numeric, 5-1
 - palette, 1-6
 - Controls palette, 1-6
 - figure, 1-7
 - showing all categories, 5-1
 - conventions used in this manual, *ix*
 - Convert from/to Dynamic Data Express VIs, 5-3
 - creating
 - See also* adding
 - controls, 2-5, 2-13
 - graph indicators, 2-5
 - indicators, 2-13
 - NI-DAQmx tasks, 4-2
 - customizing
 - block diagrams, 2-13
 - controls, 1-16
 - front panels, 2-5
 - indicators, 1-17
 - menus, 5-5
 - simulated signals, 3-4
- D**
- DAQ Assistant Express VI, 4-2, 4-12
 - DAQ devices, 4-2
 - data
 - displaying
 - from DAQ devices, 4-5
 - in tables, 2-9, 2-14
 - graphing from DAQ devices, 4-5
 - saving
 - to a file, 3-13, 3-14
 - when prompted by a user, 3-15
 - storing, 3-14
 - data flow, 1-10, 1-14, 1-19
 - data types
 - dynamic, 5-3
 - overview, 5-3
 - deleting wires, 1-11
 - deselecting objects, 1-10
 - diagnostic tools (NI resources), A-1
 - displaying
 - data from DAQ devices, 4-5
 - data in tables, 2-9, 2-14
 - errors in Context Help window, 2-14
 - signals in a graph, 1-15
 - documentation
 - conventions used in this manual, *ix*
 - introduction to this manual, *ix*
 - NI resources, A-1
 - drivers
 - instrument, 4-7
 - NI resources, A-1
 - dynamic data, converting from and to, 5-3
- E**
- Error list window, 2-8, 2-14
 - errors, 2-14
 - displaying in Context Help window, 2-14
 - list, 2-8, 2-14
 - window, 2-8, 2-14
 - example VIs
 - NI Example Finder, 2-11
 - examples (NI resources), A-1
 - Execution Control palette, 2-6
 - execution speed, controlling, 2-9
 - Express VIs, 1-20
 - Amplitude and Level Measurements, 3-3, 3-9
 - Build Table, 2-9

- Comparison, 3-11
- configuration dialog boxes, 1-20
- Convert from/to Dynamic Data, 5-3
- DAQ Assistant, 4-2, 4-12
- Filter, 3-7
- Formula, 1-12
- inputs, 1-20
- Instrument I/O Assistant, 4-9, 4-14
- Scaling and Mapping, 1-12
- Simulate Signals, 1-8
- Time Delay, 2-9
- Write To Measurement File, 3-13, 3-17

F

files

- grouping, 5-5
- saving to other formats, 5-4

Filter Express VI, 3-7

Formula Express VI, 1-12, 3-5

front panel, 1-5, 1-19, 2-9

- Acquiring a Signal VI (figure), 1-2

adding

- controls, 1-6
- visual cues, 3-10

controls, 1-19, 3-17

customizing, 2-5

indicators, 1-19

modifying, 2-8

showing, 1-11

- Warning Light VI (figure), 3-2

functions, 5-2

- Merge Signals, 1-15, 2-5

Functions palette

- figure, 1-12

- showing all categories, 5-2

G

Getting Started window, 1-4, 3-2

- figure, 1-3

graph indicators, creating, 2-5

graphing

- data from DAQ devices, 4-5

- two signals, 1-15

grouping files, 5-5

H

help

- Context Help window, 2-2, 2-12, 3-3

- LabVIEW Help, 1-12, 1-20

- searching, 2-3, 2-11, 2-13

- LabVIEW resources, 1-20, 2-12

- searching, 2-4, 2-11, 2-13

- technical support, A-1

I

indicators, 1-19, 3-17, 5-1

- adding numeric, 2-5

- configuring, 1-21

- creating, 2-13

- customizing, 1-17

- data type, 5-3

- numeric, 5-1

- removing, 2-8

Input palette, 2-3

inputs, Express VI, 1-20

Instrument Driver Network, 4-7

instrument drivers, 4-7

- finding, 4-13

- installing, 4-13

- NI resources, A-1

Instrument I/O Assistant Express VI, 4-9, 4-14

instruments

- acquiring information, 4-11

- communicating, 4-7

- parsing information, 4-11

- selecting, 4-10

introduction to this manual, *ix*

K

knob control, customizing (figure), 1-16
KnowledgeBase, A-1

L

LabVIEW
 help resources, 2-12
 other features, 5-1
 projects, 5-5
LabVIEW Help, 1-12, 1-20
 searching, 2-3, 2-11, 2-13
LEDs, palette, 3-10
LVM. *See* .lvm files
.lvm files, 3-14, 3-17

M

manual. *See* documentation
marquee, 2-9
menus, customizing, 5-5
Merge Signals function, 2-5
 figure, 1-15
modifying
 front panels, 2-8
 signals, 1-11, 2-3

N

National Instruments support and
 services, A-1
New dialog box, 1-4, 1-18, 3-2
 figure, 1-5
NI Example Finder, 2-11
NI Instrument Driver Finder, 4-13
NI Instrument Driver Network, 4-7
NI-DAQmx tasks, 4-13
 creating, 4-2
numeric controls, 5-1
 palette, 1-7

O

objects
 deselecting, 1-10
 wiring on the block diagram, 1-10
Operating tool, 1-11
outputs, Express VI, 1-20

P

palettes
 Arithmetic & Comparison, 1-12
 Controls, 1-6
 Execution Control, 2-6, 2-14
 Functions, 1-12
 Input, 2-3
 LEDs, 3-10
 searching, 2-6
 showing all categories, 5-1, 5-2
parsing information for instruments, 4-11
placing objects on the block diagram from the
 help, 2-13
Positioning tool, 1-10
programmatically controlling VIs, 5-4
programming examples (NI resources), A-1
projects, 5-5
property dialog boxes, 1-21
publishing VIs on the Web, 5-4

R

related documentation, *x*
removing indicators, 2-8
Run button, 1-6, 1-11
 broken, 2-8, 2-14
running VIs, 1-11
 continuously, 2-6

S

saving data
 different file formats, 5-4
 Save Data VI block diagram (figure), 3-16

- to files, 3-13, 3-14, 3-17
- when prompted by user, 3-15, 3-16
- Scaling and Mapping Express VI
 - defining slope, 1-12
- searching
 - examples, 2-11
 - help, 2-4, 2-11, 2-13
 - palettes, 2-6
- selecting
 - instruments, 4-10
 - objects, 1-10
- shared libraries, building, 5-5
- signals
 - acquiring, 4-2
 - analyzing, 3-9
 - changing type, 1-8
 - graphing, 1-15
 - modifying, 1-11, 2-3
- Simulate Signal Express VI, 1-8
- simulated signals, customizing, 3-4
- software (NI resources), A-1
- subVIs, 5-2
- system requirements, x

T

- tables, 2-9
 - displaying data, 2-14
- tasks
 - adding new channels, 4-6
 - NI-DAQmx, 4-13
- TDM. *See* .tdm files
- .tdm files, 3-17
- .tdms files, 3-17
- technical support, A-1
- template VIs, 1-3, 1-4, 1-18
- text-based languages, calling code, 5-4, 5-5
- Time Delay Express VI, 2-9
- tools
 - Operating, 1-11
 - Positioning, 1-10

- Wiring, 1-10

- training and certification (NI resources), A-1
- troubleshooting (NI resources), A-1

U

- user interface. *See* front panel

V

- virtual instruments. *See* VIs
- VIs, 1-1
 - blank, 2-2
 - building, 1-2
 - customizing menus, 5-5
 - icons, 5-2
 - new, 2-2
 - programmatically controlling, 5-4
 - publishing on the Web, 5-4
 - running, 1-11
 - continuously, 2-6
 - subVIs, 5-2
 - template, 1-3, 1-4, 1-18
- voltage, analyzing, 3-9

W

- Warning Light VI block diagram (figure), 3-12
- warning lights, adding, 3-10
- Web resources, A-1
- While Loop, 2-7
- wires
 - broken, 2-8, 2-14
 - deleting, 1-11
- wiring
 - objects on the block diagram, 1-10
 - tool, 1-10
- Write to Measurement File Express VI, 3-14, 3-17
 - saving data, 3-14